





















































































































































		
B6.985X1.270	C0.50	C0.400	C0.450	C0.500	C0.580	C0.600					
											
C0.700	C0.750	C0.790	C0.800	C0.812	C0.900	C1.000					
											
C1.016	C1.100	C1.200	C1.270	C1.300	C1.400	C1.500					
											
C1.549	C1.600	C1.700	C1.778	C1.800	C1.900	C2.000					
											
C2.007	C2.200	C2.307	C2.500	C2.515	C2.600	C2.700					
											
C2.800	C2.815	C2.900	C3.000	C3.100	C3.200	C3.300					
											
C3.500	C3.810	C4.000	C4.110	C4.200	C4.300	C4.400					
											
C4.500	C4.800	C4.900	C5.000	C5.100	C5.300	C7.000					
											
C7.200	C15.000	C15.200	C030	C035	C040	C045	C050	C055	C060		
											
C065	C080	C090	D0.3	D0.4	D0.5	D0.6	D0.7	D0.8	D0.9	D1.0	D1.1
											
D1.2	D1.3	D1.4	D1.5	D1.6	D1.9	D1.15	D2.0	D2.4	D2.5	D2.6	D3.0
											
D3.2	D3.5	D4.0	D4.5	D5.0	D5.5	D6.2	F024X120	KEYCONT3.0			
											
KEYCONT3.0_SM	M_LQS_C	M_LQS_S	R0.42X1.8	R0.52X1.9	R0.150X0.500						

R0.150X0.600	R0.220X1.000	R0.230X0.570	R0.230X0.650	R0.230X0.770
R0.240X0.450	R0.240X0.650	R0.250X0.700	R0.280X1.500	R0.300X0.720
R0.330X0.670	R0.330X0.750	R0.330X0.870	R0.340X0.550	R0.340X0.750
R0.350X0.700	R0.350X0.800	R0.400X0.920	R0.400X2.000	R0.400X3.000
R0.420X1.200	R0.420X1.800	R0.420X5.000	R0.450X0.700	R0.450X0.900
R0.500X1.000	R0.500X1.200	R0.500X1.500	R0.500X2.000	R0.500X2.250
R0.500X3.000	R0.520X1.900	R0.550X0.800	R0.600X0.700	R0.600X0.800
R0.600X1.000	R0.600X1.200	R0.600X1.300	R0.600X1.600	R0.600X1.800
R0.600X1.900	R0.600X2.000	R0.600X2.100	R0.600X2.500	R0.620X1.220
R0.620X5.200	R0.650X2.100	R0.650X2.600	R0.700X0.800	R0.700X1.200
R0.700X1.300	R0.700X1.700	R0.700X2.000	R0.700X2.100	R0.700X2.450
R0.700X2.500	R0.760X1.400	R0.800X0.600	R0.800X1.000	R0.800X1.200
R0.800X1.800	R0.800X2.100	R0.820X1.420	R0.850X2.100	R0.850X2.300

 R0.850X2.500	 R0.850X2.800	 R0.865X0.800	 R0.900X0.800	 R0.900X1.000
 R0.900X1.200	 R0.900X1.600	 R0.900X1.800	 R0.900X2.200	 R0.900X2.700
 R0.900X3.100	 R0.950X2.600	 R0.960X1.600	 R1.000X1.200	 R1.000X1.400
 R1.000X1.500	 R1.000X2.000	 R1.000X3.500	 R1.050X2.300	 R1.065X1.000
 R1.100X1.000	 R1.100X1.200	 R1.100X1.400	 R1.100X2.000	 R1.100X2.500
 R1.100X3.300	 R1.200X1.400	 R1.200X1.700	 R1.200X1.800	 R1.200X2.000
 R1.200X2.200	 R1.200X2.400	 R1.200X2.600	 R1.270X2.540	 R1.300X1.200
 R1.300X1.800	 R1.300X2.400	 R1.370X2.640	 R1.400X2.000	 R1.400X2.200
 R1.400X2.600	 R1.400X3.600	 R1.500X1.200	 R1.500X1.400	 R1.500X3.400
 R1.600X2.200	 R1.600X3.200	 R1.600X3.800	 R1.600X9.000	 R1.650X2.540
 R1.700X1.400	 R1.800X1.500	 R1.800X1.600	 R1.800X2.000	 R1.800X3.400
 R1.850X2.740	 R2.000X1.800	 R2.000X2.200	 R2.000X2.600	 R2.000X5.000
 R2.000X7.500	 R2.100X2.600	 R2.100X2.800	 R2.100X3.800	 R2.200X2.400

R2.200X3.100 R2.200X5.200 R2.200X7.700 R2.300X2.800 R2.300X3.000

R2.300X3.200 R2.300X4.000 R2.400X2.500 R2.600X3.000 R2.800X2.900

R2.800X3.200 R2.800X3.500 R3.000X2.400 R3.000X3.100 R3.000X6.000

R3.200X2.600 R3.200X3.000 R3.200X6.200 R3.400X3.200 R3.500X2.050

R3.500X5.000 R3.700X2.250 R3.700X5.200 R3.800X1.800 R3.800X3.000

R4.000X1.500 R4.000X2.050 R4.000X3.200 R4.200X2.250 R4.950X2.750

R5.150X2.950 R5.500X3.000 R5.700X3.200 R9.000X0.500 R9.200X14.800

R9.400X15.000 R11.500X8.900 R11.700X9.100 R008X079 R011X045 R012X055

R012X080 R013X090 R016X032 R016X050 R020X070 R020X085 R020X100

R021X055 R024X080 R025X075 R028X071 R029X140 R030X040 R030X060

R030X070 R030X080 R030X095 R030X110 R030X120 R034X090 R035X075

R040X050 R040X070 R040X080 R040X090 R040X100 R040X120 R045X040

R045X060 R050X020 R050X060 R050X080 R050X090 R050X100 R050X110

R050X130 R050X150 R055X025 R055X050 R055X070 R055X110 R060X090

R060X100 R060X110 R060X120 R060X130 R060X140 R060X160 R060X180

R060X240 R060X330 R065X060 R065X080 R065X100 R065X120 R065X130

R065X210 R070X100 R070X110 R070X130 R070X140 R070X190 R070X250

R070X340 R075X220 R080X060 R080X085 R080X100 R080X110 R080X125

R085X105 R085X135 R095X145 R100X095 R100X130 R100X220 R100X260

R105X165 R115X110 R115X175 R120X220 R130X080 R150X120 R150X170

R160X055 R160X130 R220X312 R230X330 R260X100 R275X610 R285X620

R425X410 RULERIMP

RULERIMPB

RULERMET

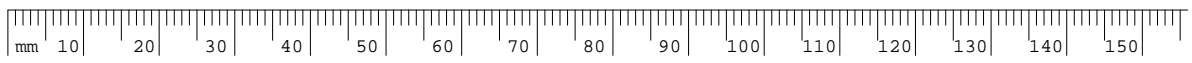

RULERMETB

S0.200 S1.000 S1.450 S1.500 S1.650 S1.700 S1.700_SP

S1.800 S2.150 S2.300 S2.300_SP S2.350 S2.500 S2.700

S2.700_SP S2.800 S2.900 S3.000 S3.100 S3.300 S3.300_SP

S3.450 S3.500 S3.650 S7.150 S7.150_SP S7.350 S055 S060

S070 S075 S080 S090 S265 SOT89 XCROSS3.000X3.000 Xfv1 Xfv2

XRING12.000X

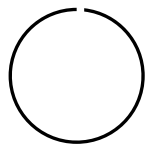
XRING18.000X

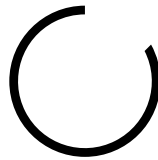
XRING20.000X

XTRENN

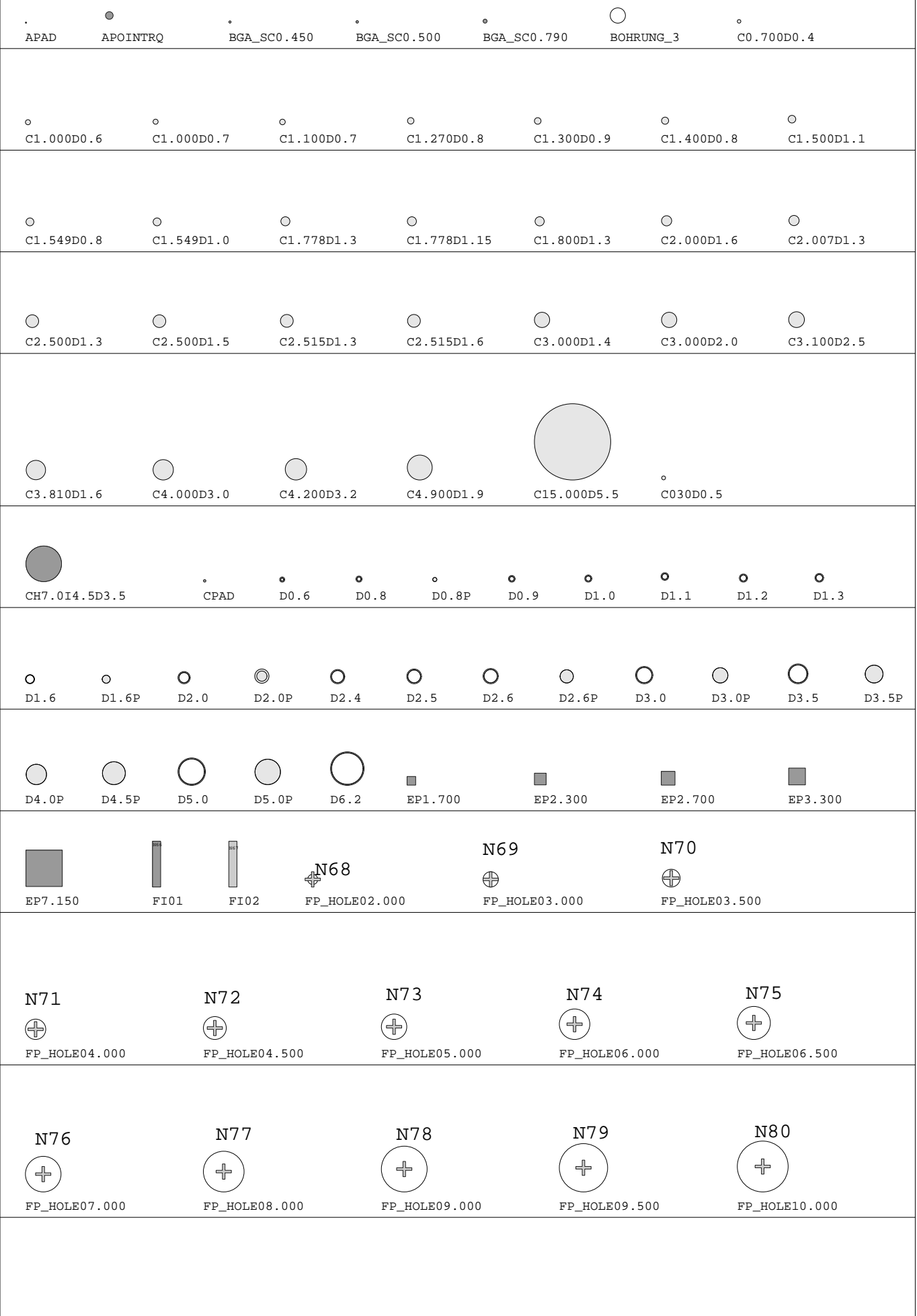

N81



FP_HOLE10.500

N82



FP_HOLE11.000

N83



FP_HOLE12.000

N84

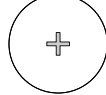

FP_HOLE13.000

N85

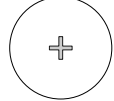

FP_HOLE13.500

N86

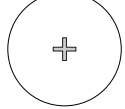

FP_HOLE15.000

N87

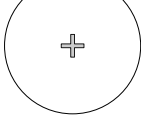

FP_HOLE18.000



KEYCONT3.0



L3.5



LOCH-3.5



M_LQS



PSOP_



PTS

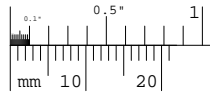

PTSL

RULER

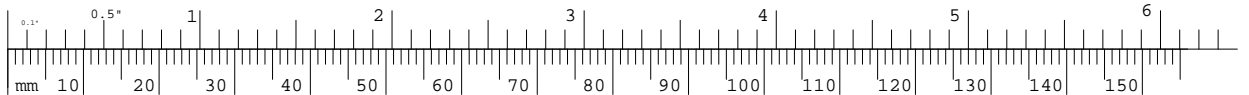

RULERB

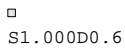

S1.000D0.6



SC0.750



SC0.790



SC0.900



SC1.500



SC030



SF024X120



SOT89

SR0.150X0.500

SR0.150X0.600

SR0.220X1.000

SR0.230X0.570

SR0.230X0.650

SR0.230X0.770

SR0.240X0.450

SR0.240X0.650

SR0.250X0.700

SR0.280X1.500

SR0.300X0.720

SR0.350X0.700

SR0.400X2.000

SR0.400X3.000

SR0.420X5.000

SR0.450X0.700

SR0.500X1.000

SR0.500X1.500

SR0.500X2.000

SR0.500X2.250

SR0.500X3.000

SR0.600X0.700

SR0.600X0.800

SR0.600X1.000

SR0.600X1.200

SR0.600X1.300

SR0.600X1.600

SR0.600X1.800

SR0.600X1.900

SR0.600X2.000



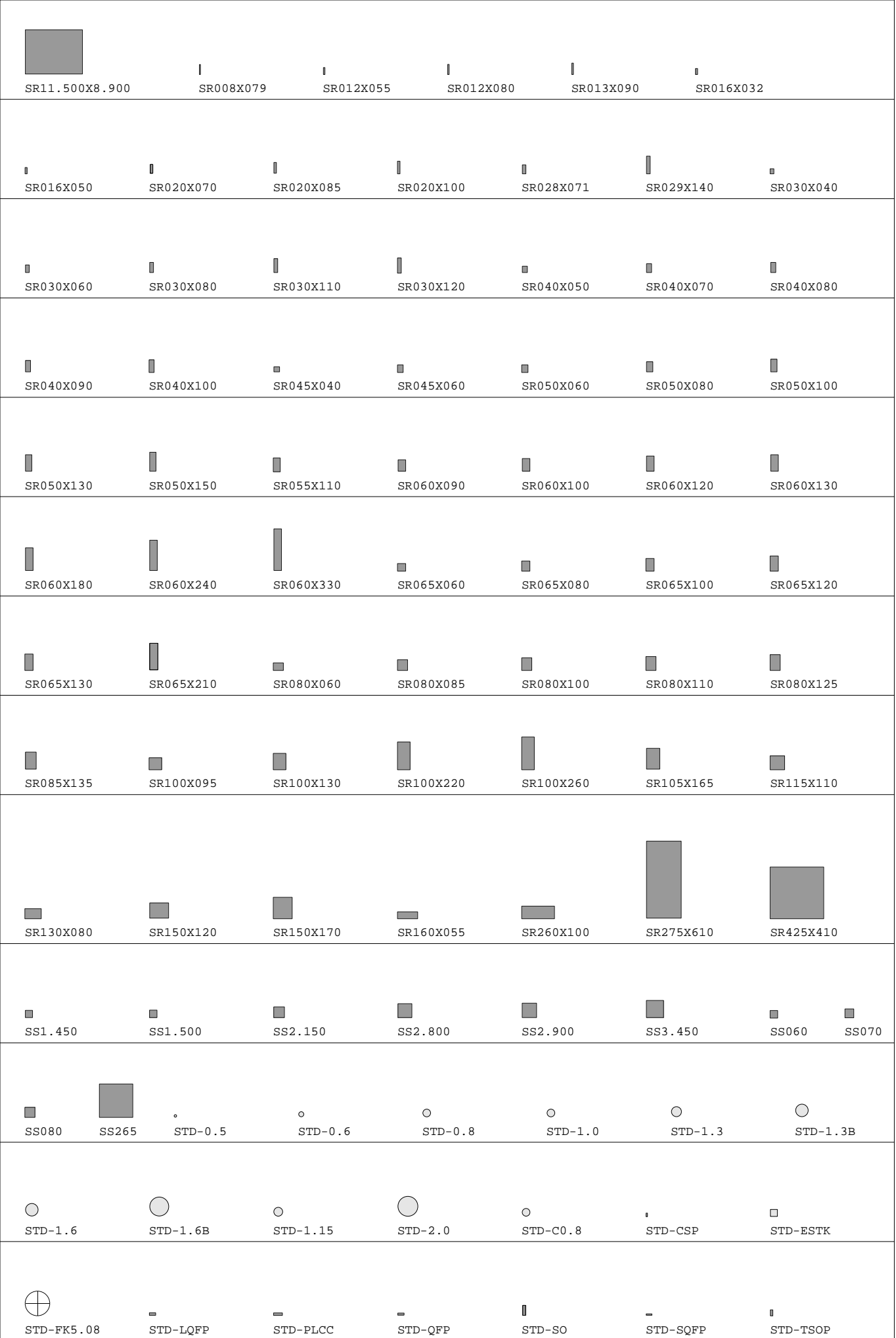

STD-TSSOP

STD-X1.3

STD-XEPC

SXTRENN

TEXTMARKE

V030

V040

V045

V050

V060

V080

VC0.700D0.4

VC0.800D0.4

VIA

VIABIG

VIASMALL

XR9.000X0.500X

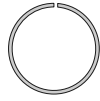

XRING12.000

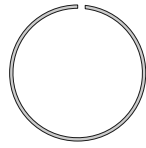

XRING18.000

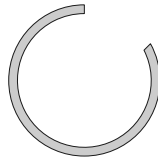

XRING20.000

XXFV1

XXFV2



60A2



N1

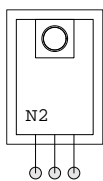

N2



N3



A_S1206

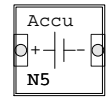

Accu
N5

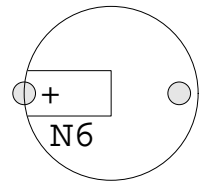

+
N6



ADJHOLE



ADJMARK

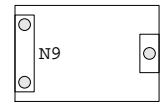

N9



AL_ELKO_VA_A



AL_ELKO_VA_B



AL_ELKO_VA_C



AL_ELKO_VA_D



AL_ELKO_VA_E



AL_ELKO_VA_F

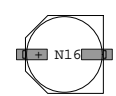

AL_ELKO_VA_G



N17



N18

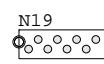

N19

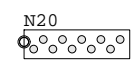

N20

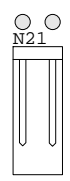

N21

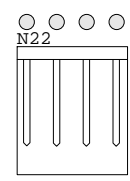

N22

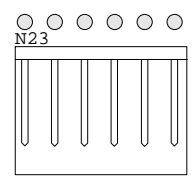

N23

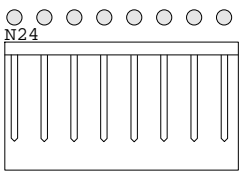

N24

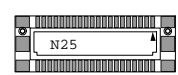

N25

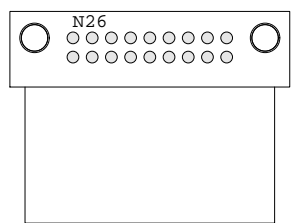

N26

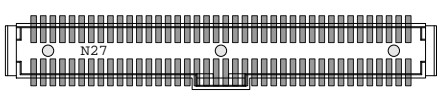

N27

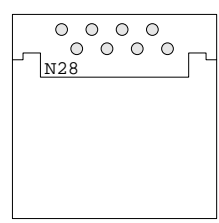

N28

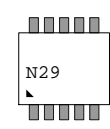

N29



BALUN_WE0805

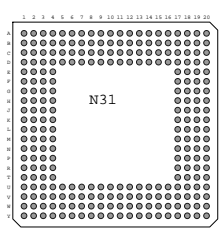

N31

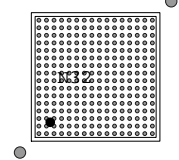

N32

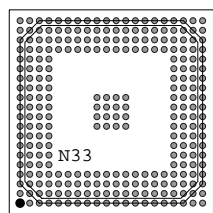

N33

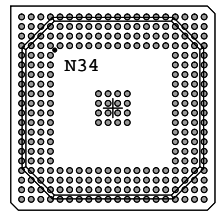

N34

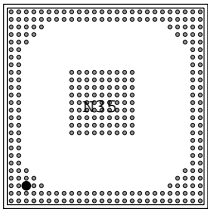

BGA297

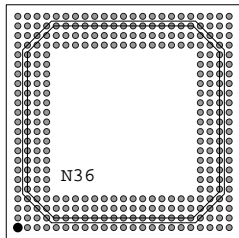

BGA304

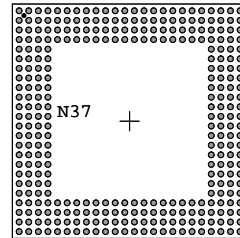

BGA320BALL

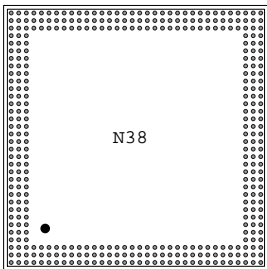

BGA372

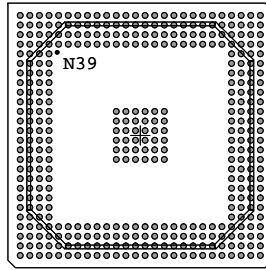

BGA388BALL

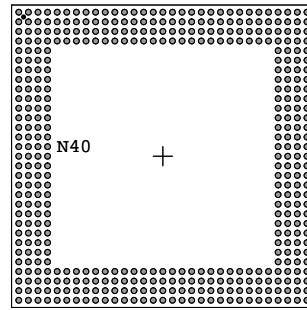

BGA432BALL

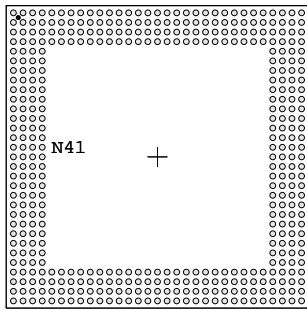

BGA432BALL_PTH

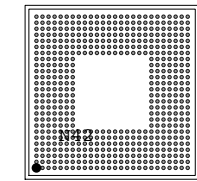

BGA532

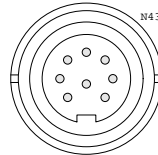

BINDER_09_0474_08



BMARK



BMARK_R

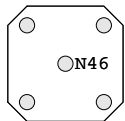

BNC

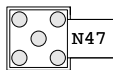

BNCSUB

SILK SCREEN PART GROUPS	
DESIGN	\$design
DWG	\$dwgno
ISSUE	\$issue
FILE	\$filename

BOARDSPEC



BOHRUNG_3.0



BSX



C7S



C02C64



C02D63



C02R25



C02R30



C02R50



C03R25



C03R45

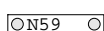

C04R25



C04R50

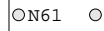

C04R50B10

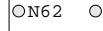

C04R60B10

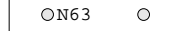

C05R50

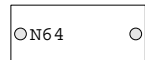

C06R75

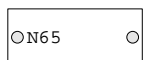

C06R75B10

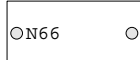

C06R85



C06R85B10



C09R105

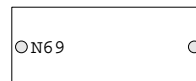

C09R105B10

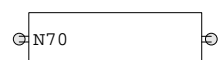

C10A70

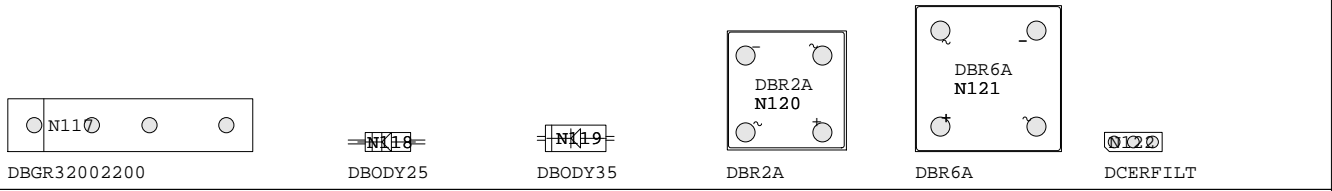
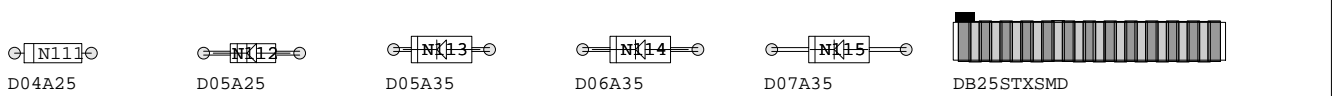
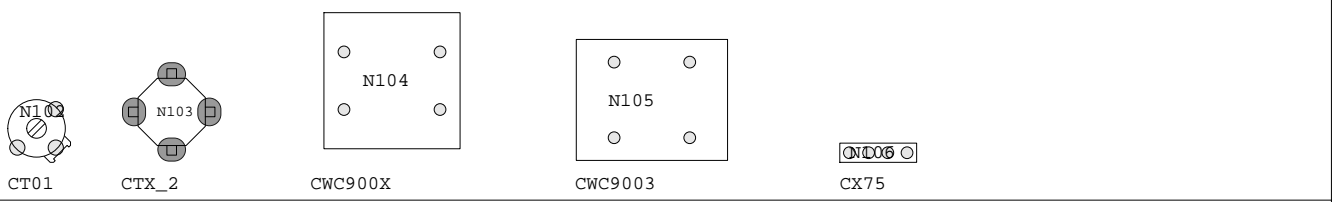
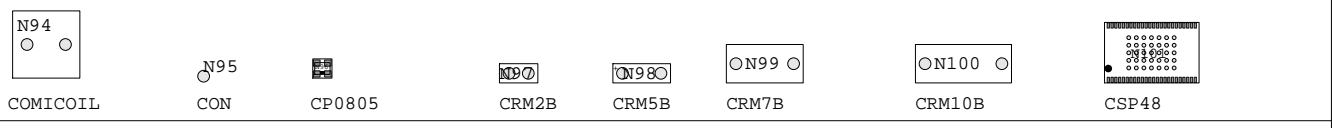
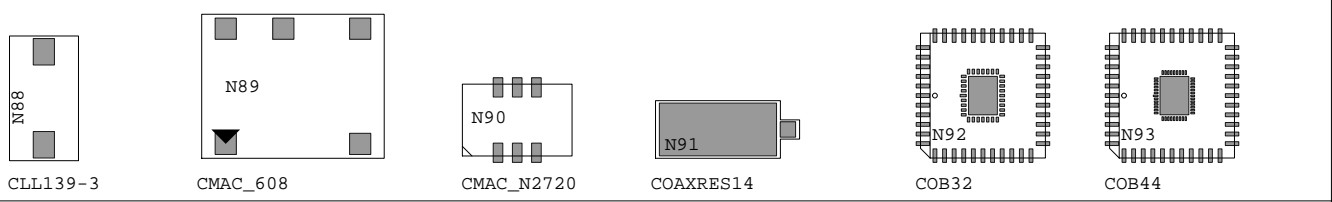
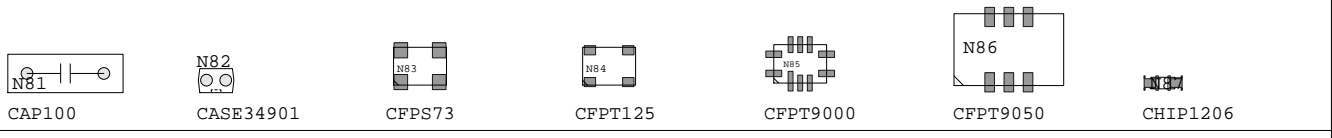
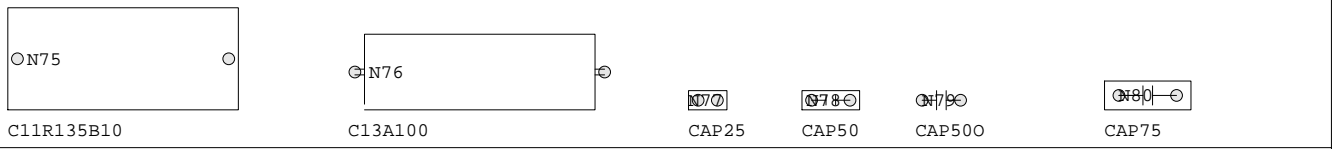
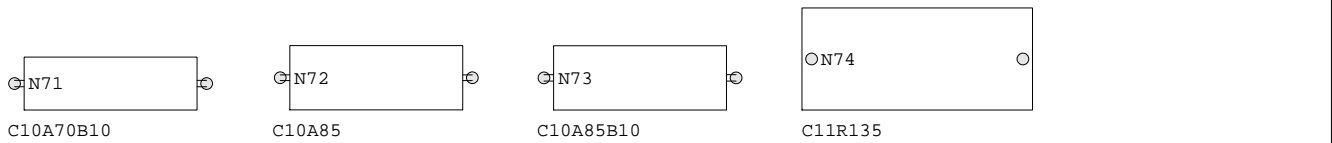

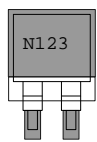

DDPAK2

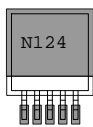

DDPAK5

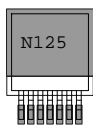

DDPAK7



DELK0B



DELK1B

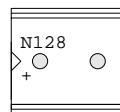

DELK2A

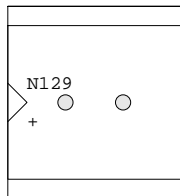

DELK2D

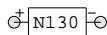

DELK12_5L



DELK17L



DELK25L

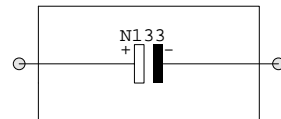

DELK30L

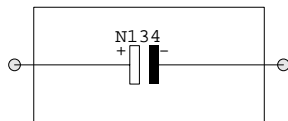

DELK35L

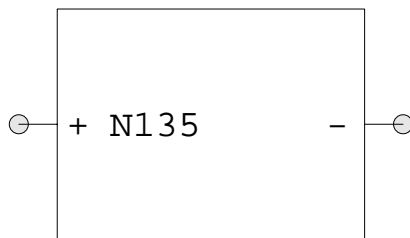

DELK50L

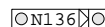

DI10



DIL2



DIL2S



DIL4



DIL4S



DIL6



DIL6P4



DIL6S



DIL8



DIL8S



DIL10



DIL10S

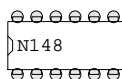

DIL12

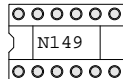

DIL12S

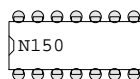

DIL14

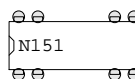

DIL14P8

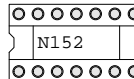

DIL14S

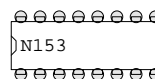

DIL16

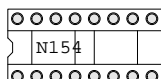

DIL16S

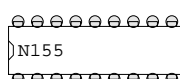

DIL18

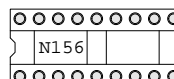

DIL18S

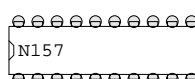

DIL20

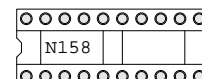

DIL20S

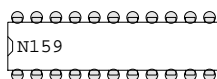

DIL22

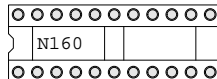

DIL22S

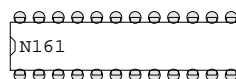

DIL24

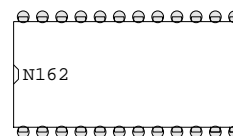

DIL24B

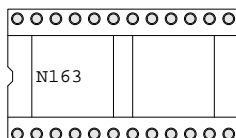

DIL24BS

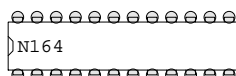

DIL24NT

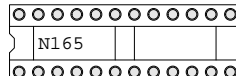

DIL24S

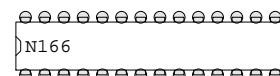

DIL28

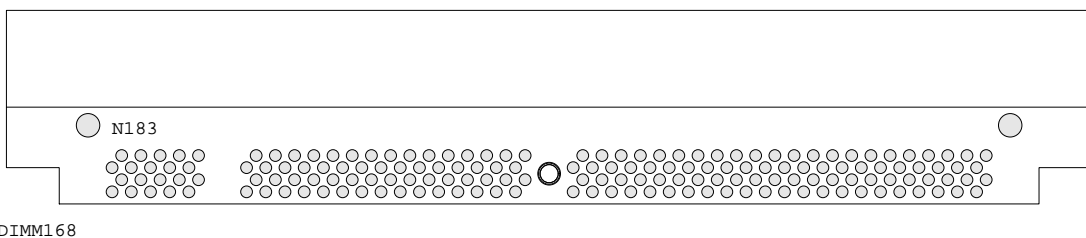
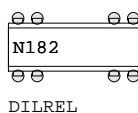
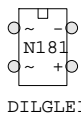
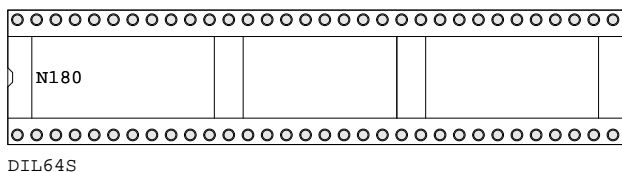
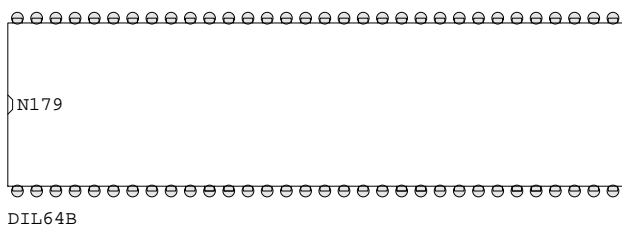
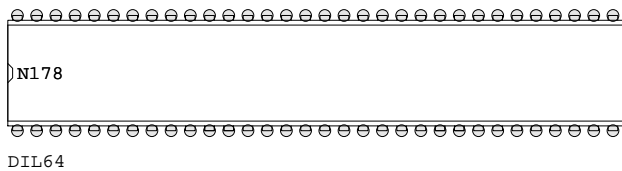
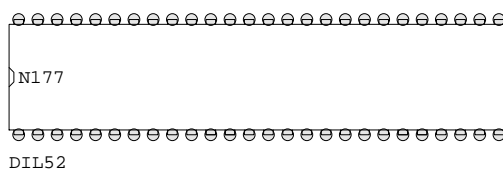
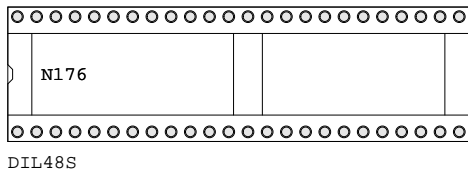
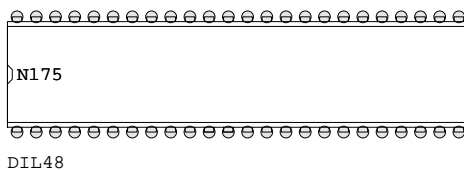
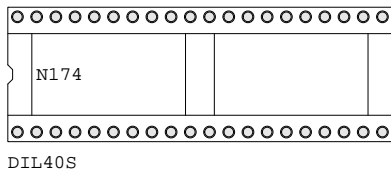
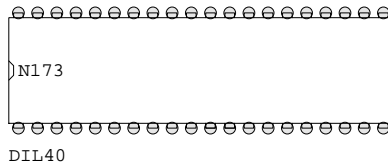
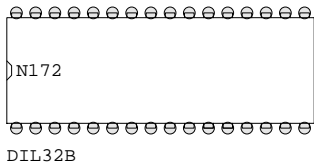
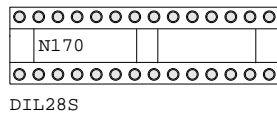
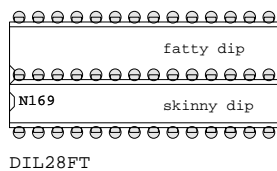
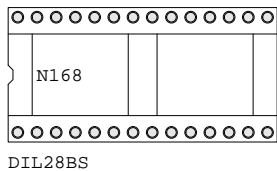
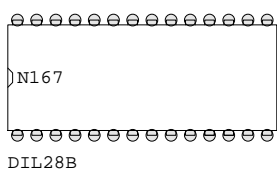

DIO0D

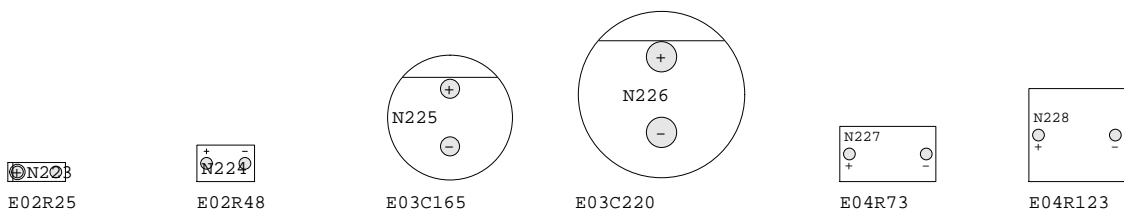
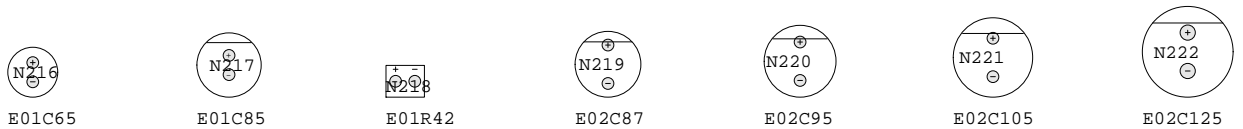
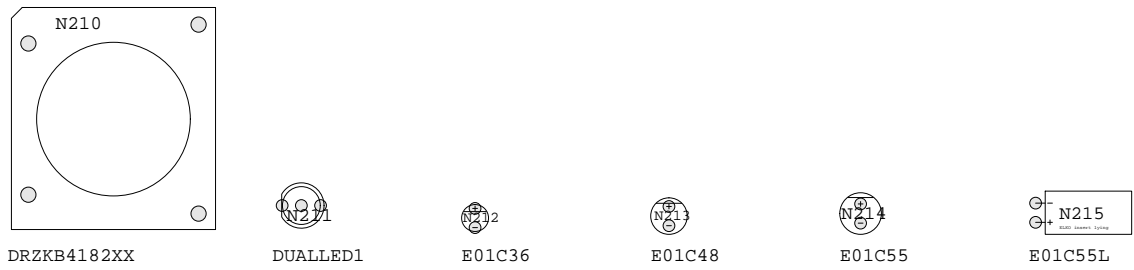
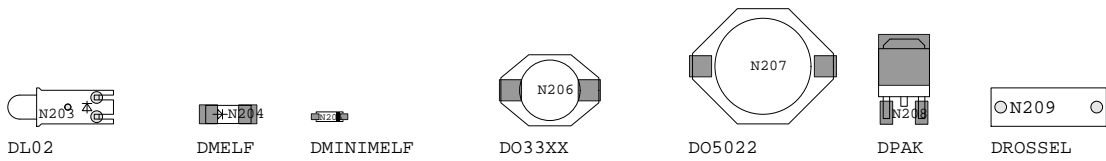
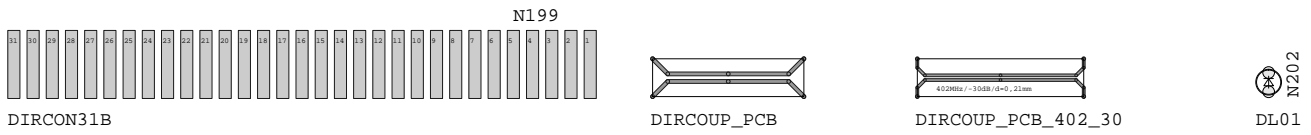
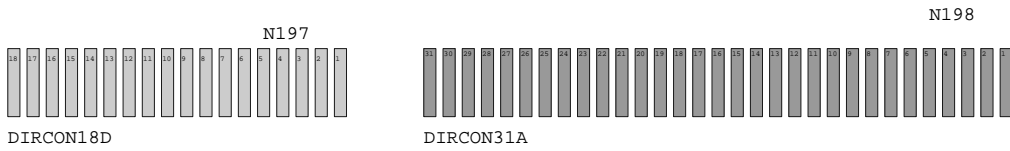
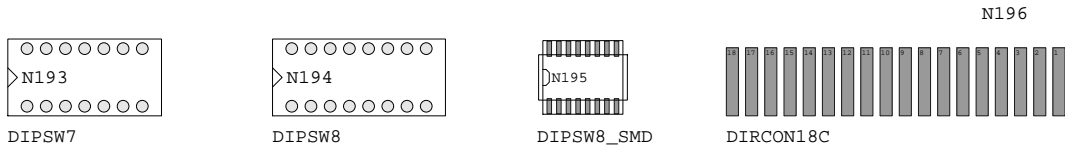
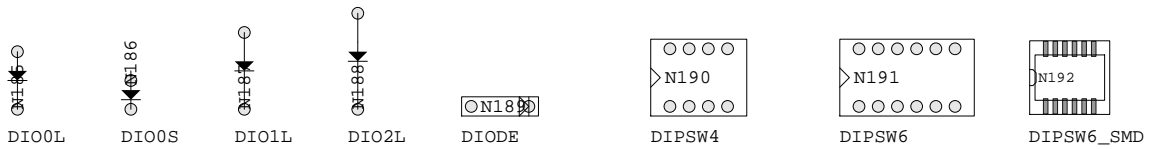

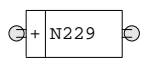

E06A61

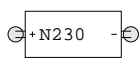

E06A61B13

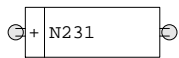

E08A66

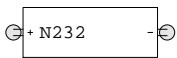

E08A66B13

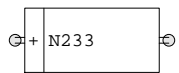

E08A85

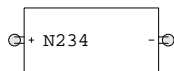

E08A85B10



E10A103



E10A103B13



E12A105



E12A105B10

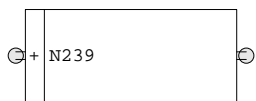

E12A122



E12A122B13

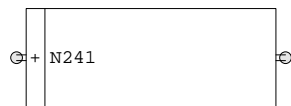

E14A130



E14A130B10



E14A160

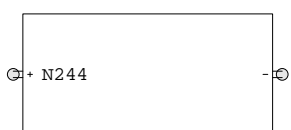

E14A160B10



E14A183B10



E14A185

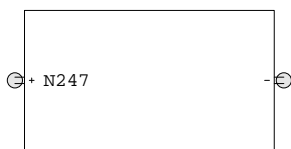

E14A185B13



E18A210



E18A210B13



E_FK_D



EDGE



ELKO



ELKO25



ELKO25L



ELKO50

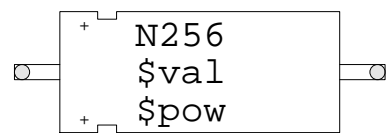

ELKO_L16_37

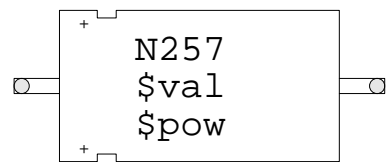

ELKO_L20_37

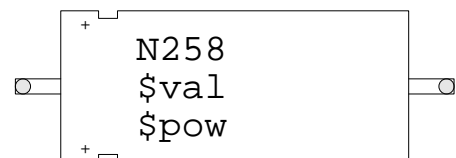

ELKO_L20_46



ELKO_S6



ELKO_S8



EPTSSOP28



EVQ



F_451SMD

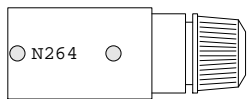

F_H5X20L1

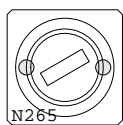

F_H6X32S1

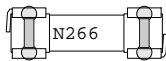

F_LP5X20L1

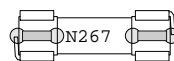

F_LP5X20L2

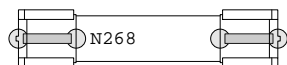

F_LP6X32L1

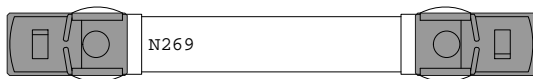

F_LP8X50L1



F_LP1200V



F_OMF63

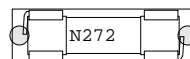

F_S5X20L1

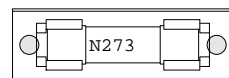

F_S5X20L2



F_S250V4AS



FBR20



FET



FETDGS

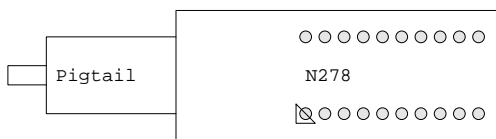

FIBERMOD20

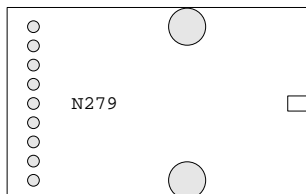

FIBERTRANSCEIVER_1X9

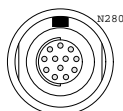

FISCHER_DBP103A062

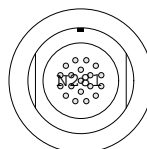

FISCHER_DBPU1031A019

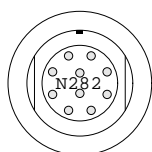

FISCHER_DBPU1031Z010

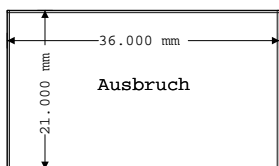

FP_CUTOUT36X21

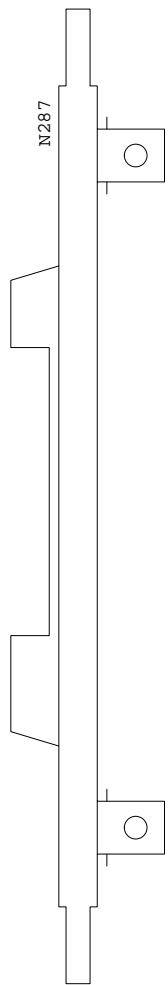

FP_EUROFLST



FP_HOLE03.000



FP_HOLE03.000LED



FP_HOLE03.500



FP_HOLE04.000

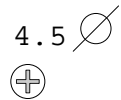

FP_HOLE04.500

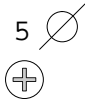

FP_HOLE05.000

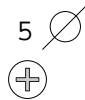

FP_HOLE05.000MINISWITCH

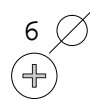

FP_HOLE06.000

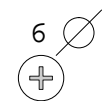

FP_HOLE06.000LED

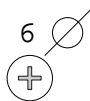

FP_HOLE06.000LED6

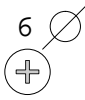

FP_HOLE06.000SWITCH1

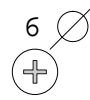

FP_HOLE06.000SWITCH2

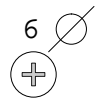

FP_HOLE06.000SWITCH4

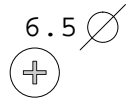

FP_HOLE06.500

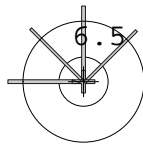

FP_HOLE06.500DS04_2

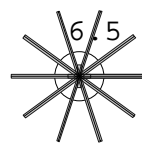

FP_HOLE06.500DS05

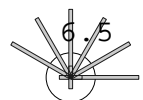

FP_HOLE06.500DS12_2

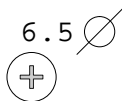

FP_HOLE06.500PSWITCH

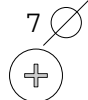

FP_HOLE07.000

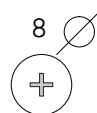

FP_HOLE08.000

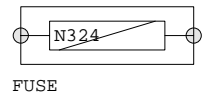
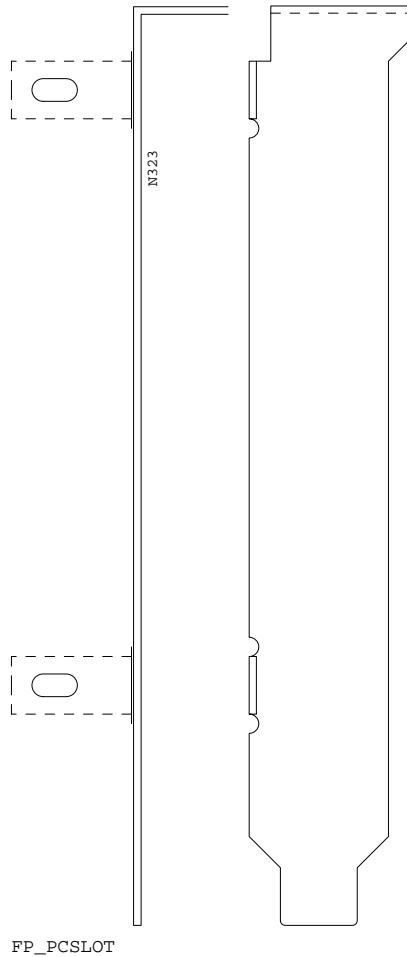
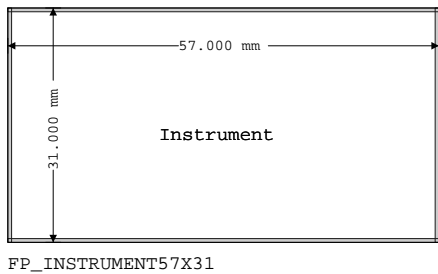
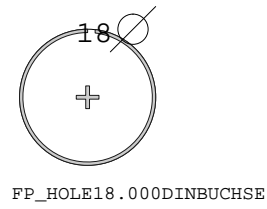
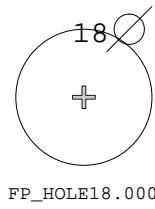
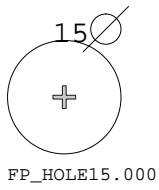
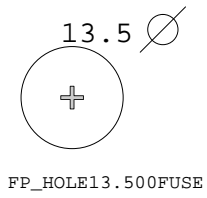
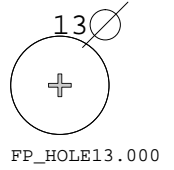
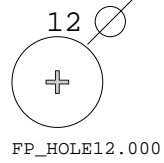
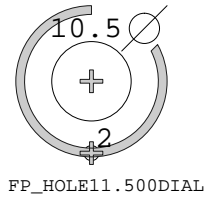
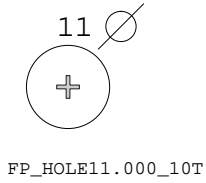
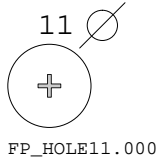
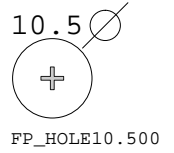
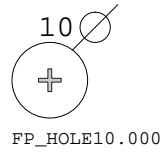
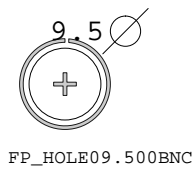
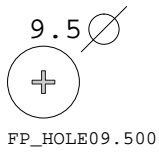
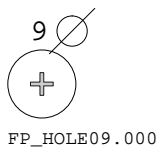

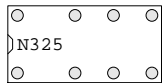

G5V_2

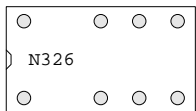

G6CN_2_BS

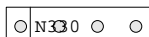

GLEI

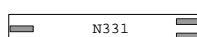

HAMLIN_59160



HC-52/U

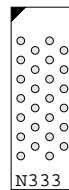

HD26



HIROSE_DF9_31S



HIROSE_DF13_5P_H



HIROSE_DF13_5P_V

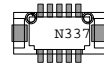

HIROSE_DF13_10



HIROSE_DF13_20

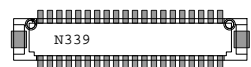

HIROSE_DF13_40



HIROSE_DF14_20



HIROSE_DF14_25

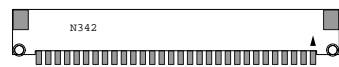

HIROSE_DF14_30



HMC1053



HOLE16P



HOLE26P



HOLE30NP



HOLE30P



HOLE35



HOLE35P



HOLE40P



HOLE45P



HOLE50NP



HOLE50P

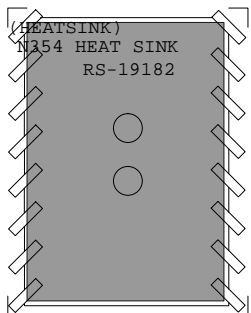

N354

HS1

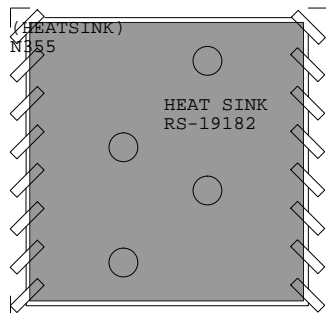

N355

HS2

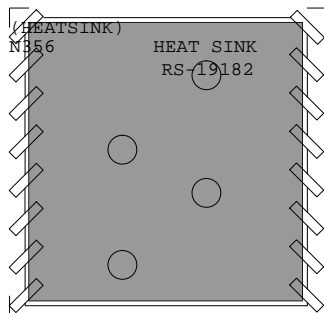

N356

HS3

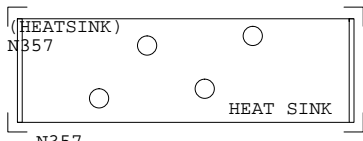

N357

HS4

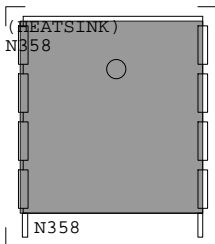

N358

HS5

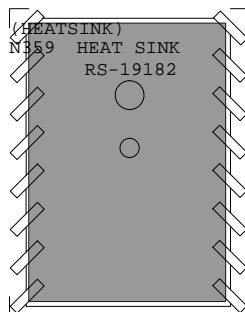

N359

HS6

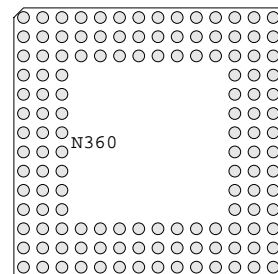

I80386

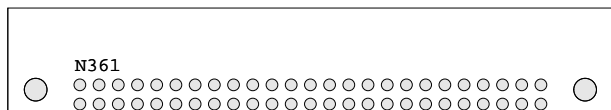

IDC50

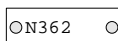

INDUCT

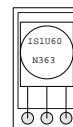

IS1U60

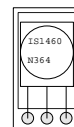

IS1460

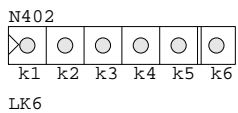
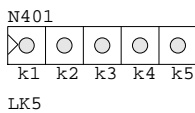
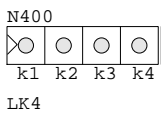
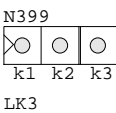
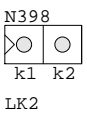
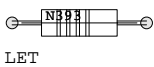
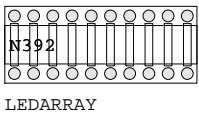
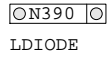
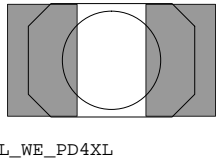
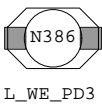
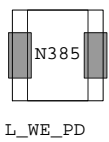
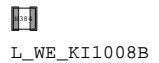
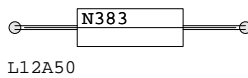
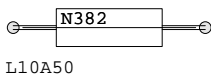
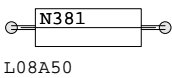
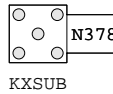
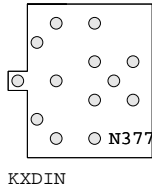
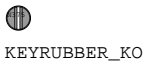
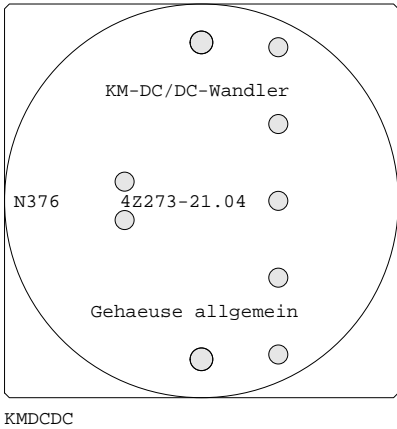
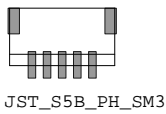
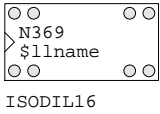
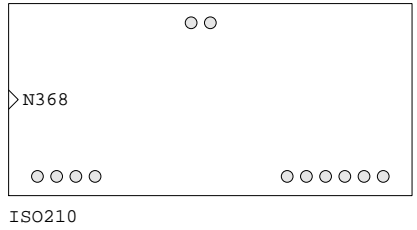
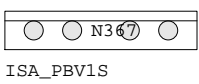
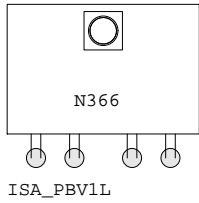
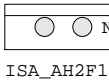

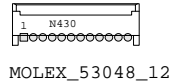
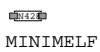
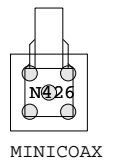
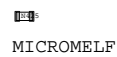
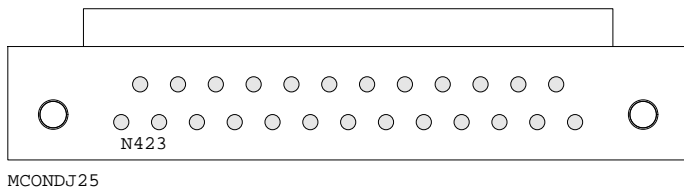
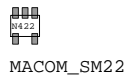
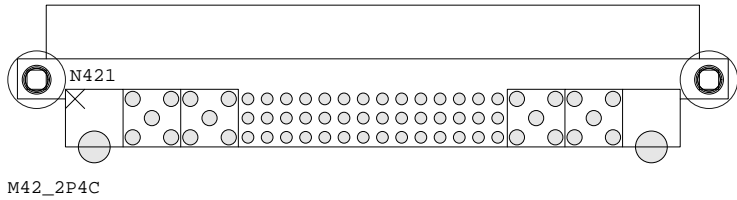
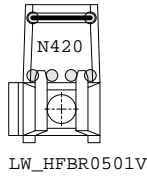
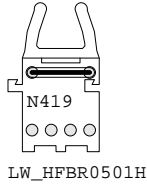
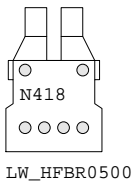
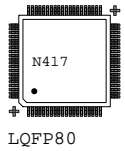
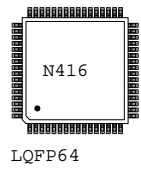
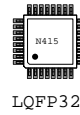
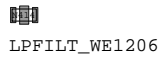
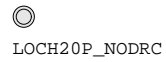
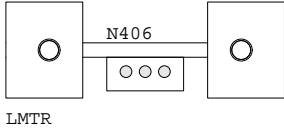
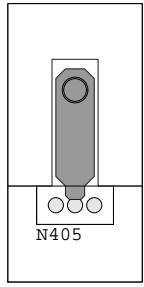
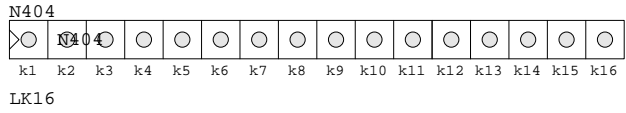
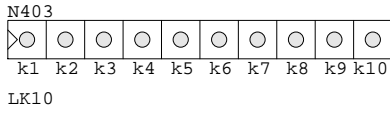

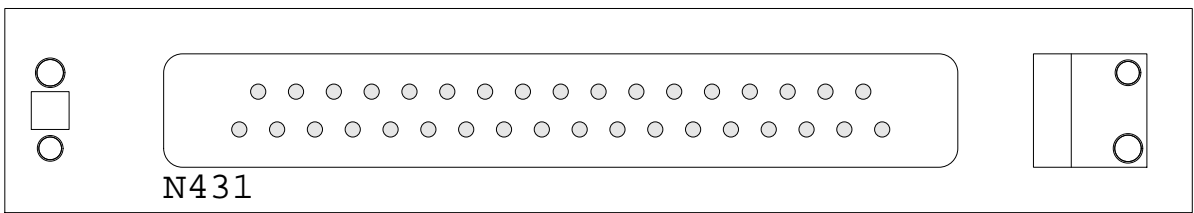

MOTCON35

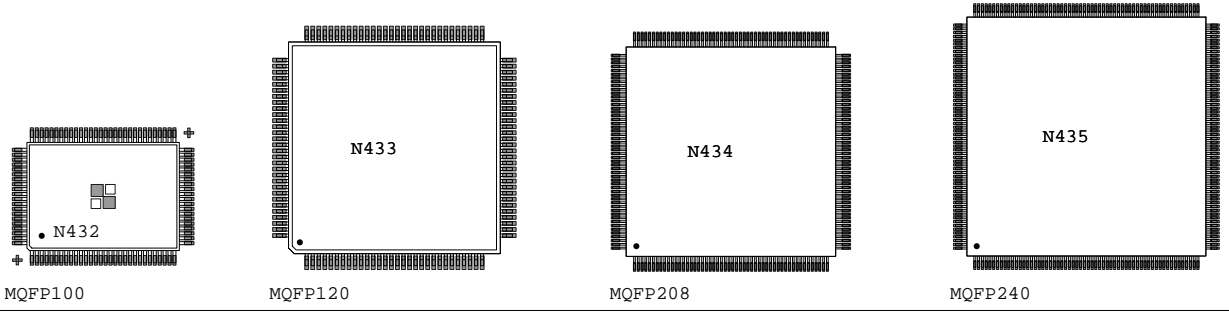

MQFP100

MQFP120

MQFP208

MQFP240

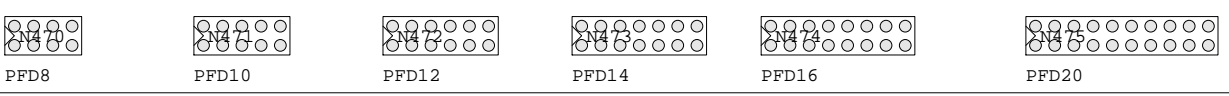
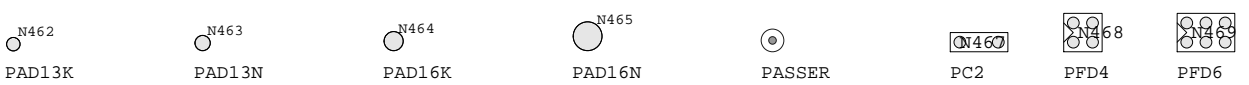
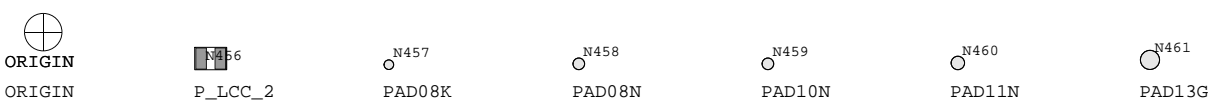
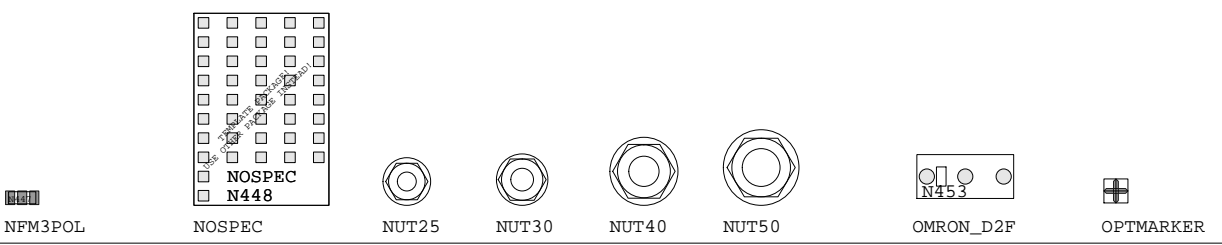
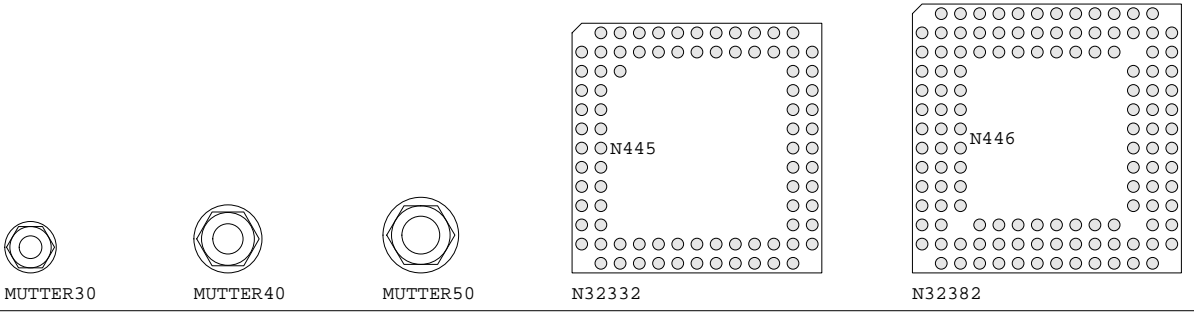
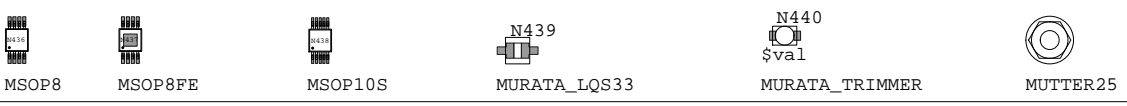

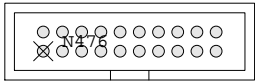

PFD20U

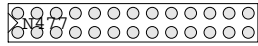

PFD26

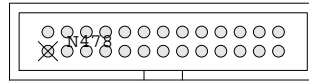

PFD26U

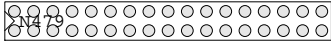

PFD34

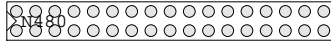

PFD34S

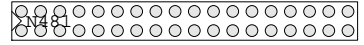

PFD36

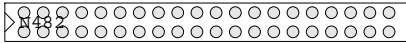

PFD40

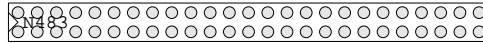

PFD50

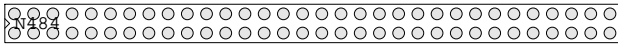

PFD64

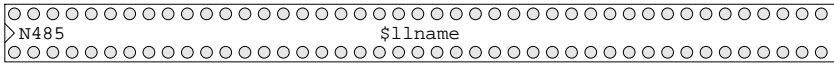

PFD86



PFE4

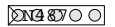

PFE5

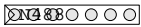

PFE7

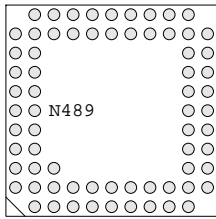

PGA68

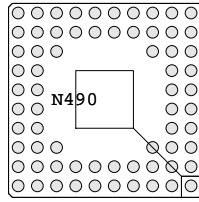

PGA68A

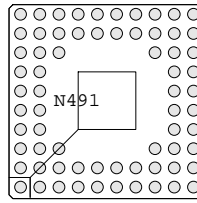

PGA68MC

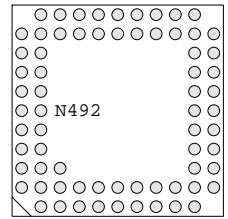

PGA68N

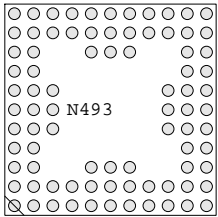

PGA84

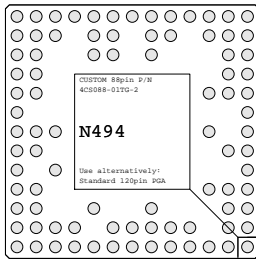

PGA88A

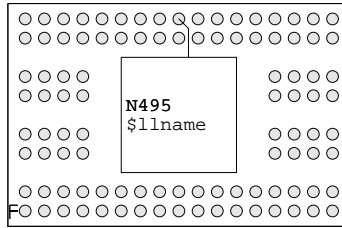

PGA100R

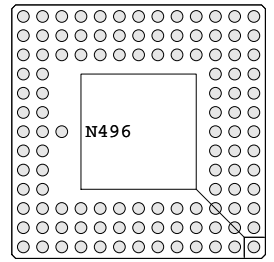

PGA104A

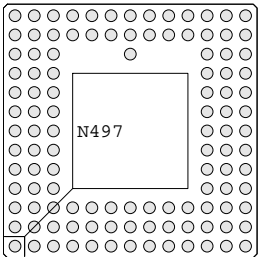

PGA104MC

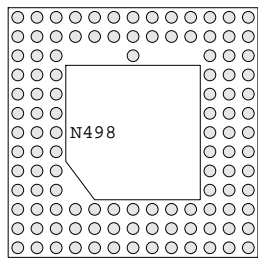

PGA114

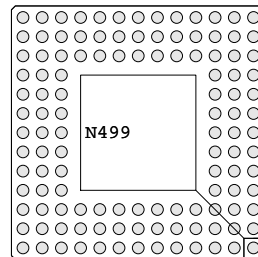

PGA120A

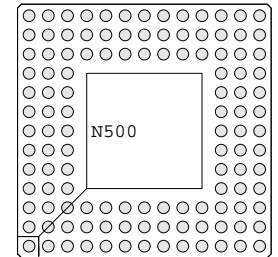

PGA120MC

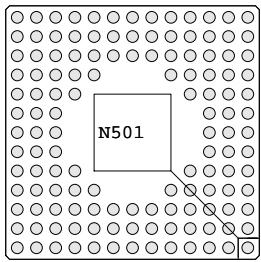

PGA132A

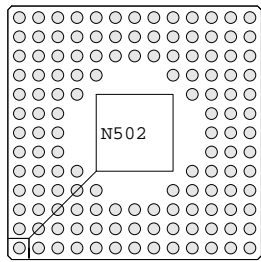

PGA132MC

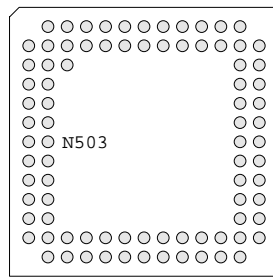

PGA1384

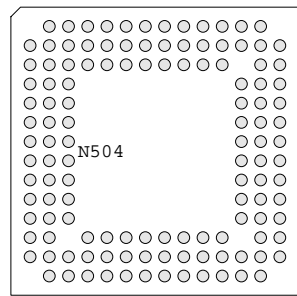

PGA14125

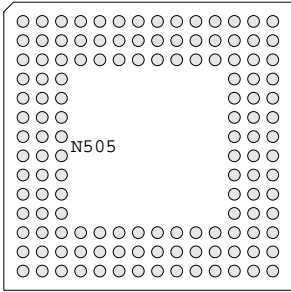

PGA14132

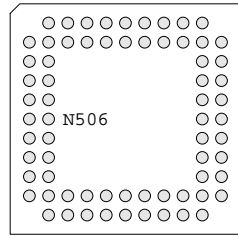

PGA_I286

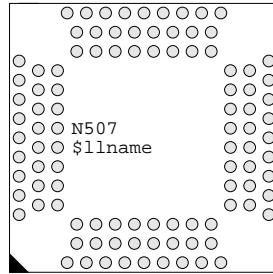

PGA_I386SX



PIL4

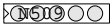

PIL5



PIN



PIN-0.8



PIN1



PLCC16



PLCC20

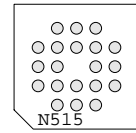

PLCC20S

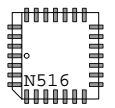

PLCC28

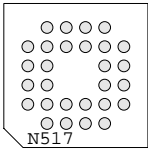

PLCC28S

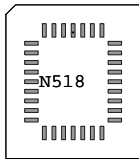

PLCC32

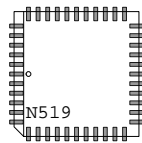

PLCC44

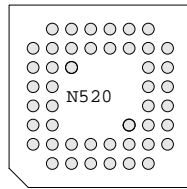

PLCC44S

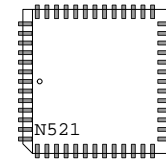

PLCC52

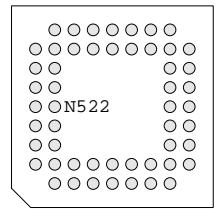

PLCC52S

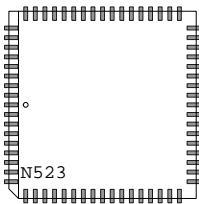

PLCC68

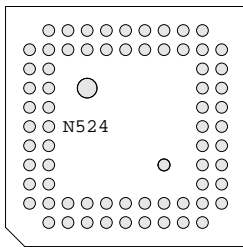

PLCC68S

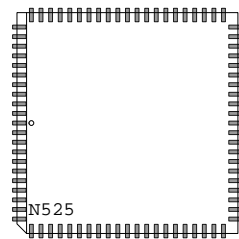

PLCC84

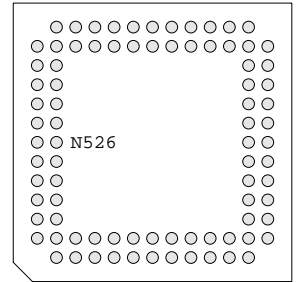

PLCC84S



POT0L



POT0S



POT0SK



POT1S

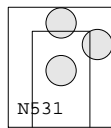

POW25CON



POWCON_6MM



POWCON_M5



PQFN16



PQFN32



PQFN64



PQFP32

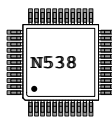

PQFP44S10

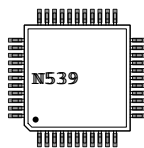

PQFP44S14



PQFP48S07

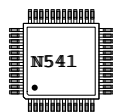

PQFP48S10

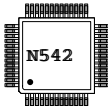

PQFP52

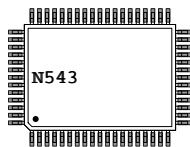

PQFP64REC

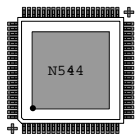

PQFP80_ED

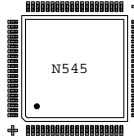

PQFP80A

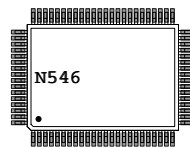

PQFP80REC

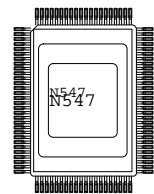

PQFP100

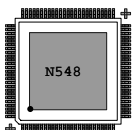

PQFP100_ED

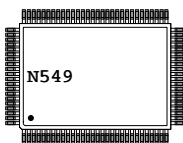

PQFP100REC

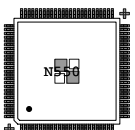

PQFP100SPZ

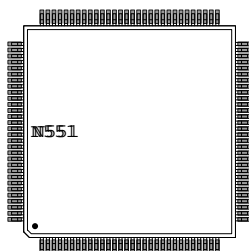

PQFP120

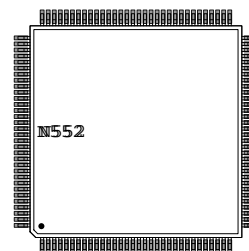

PQFP128

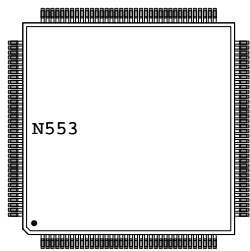

PQFP144

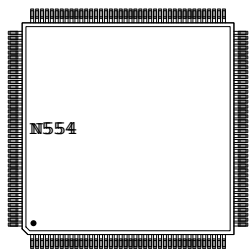

PQFP160

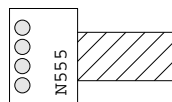

PRESSTRD



PRSENS



PSOP8_



PSOP8

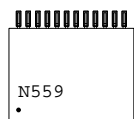

PULSE_H5007

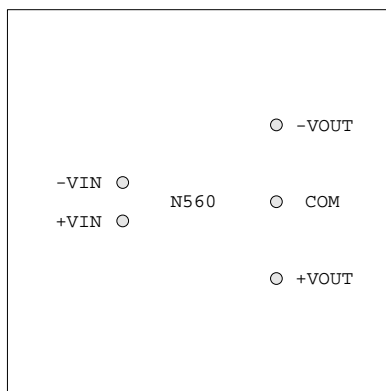

PWR

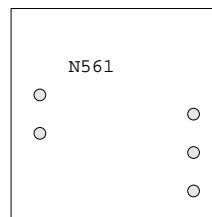

PWR4XX

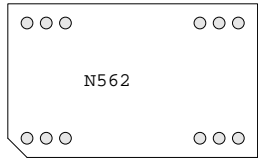

PWR59XX

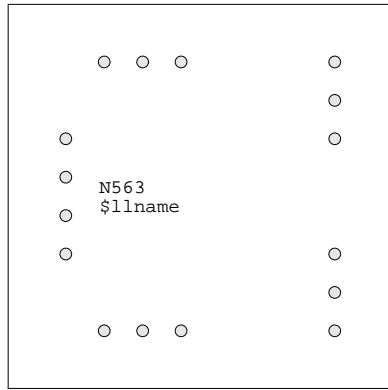

PWR1017



QCC8

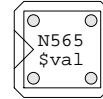

QDIL8

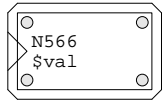

QDIL14



QFN16LP3



QFN24LP4

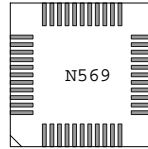

QFP44

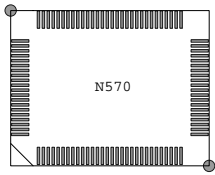

QFP100

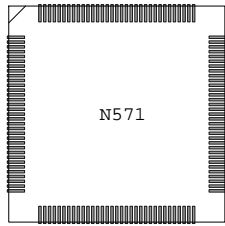

QFP132

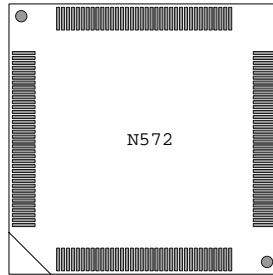

QFP144

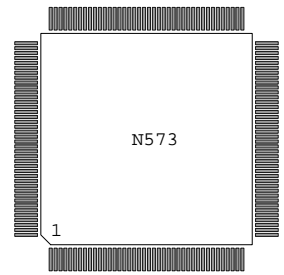

QFP160

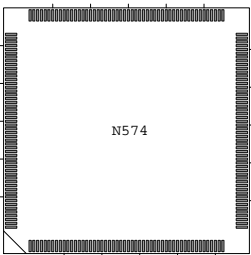

QFP208

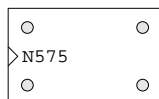

QG



QKL

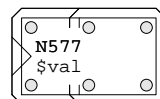

QMDIL14



QQQ130



QSOP16



QSOP20



QSOP24



QSOP28



QUARZ



QUARZM



R01E25



R01P25



R01R25



R02P45B10



R04A25



R05A25



R05A35

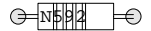

R06A35

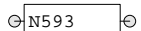

R06A45B10



R07A35



R08A50

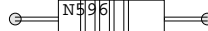

R10A50



R10A70

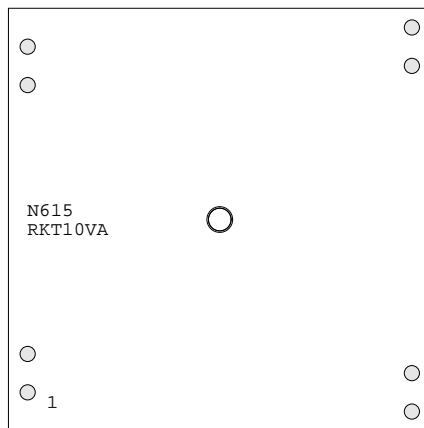
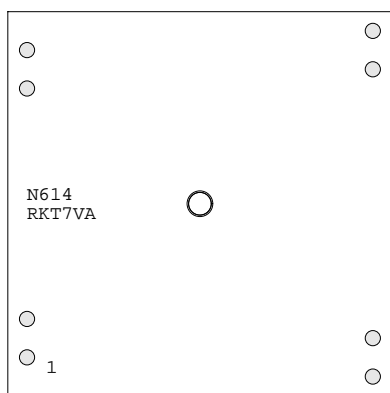
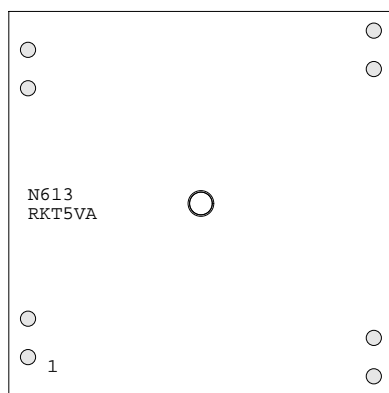
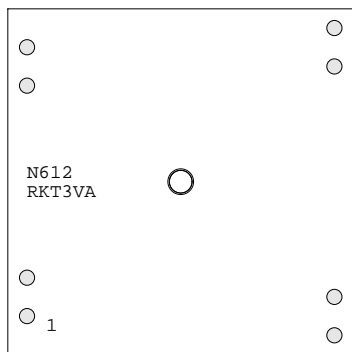
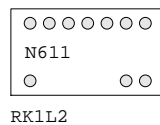
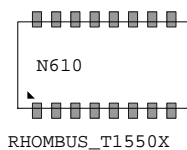
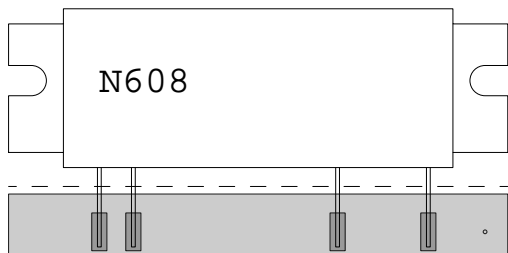
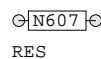
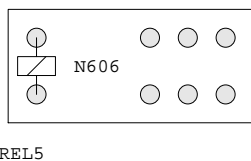
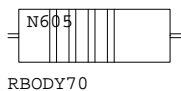
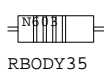
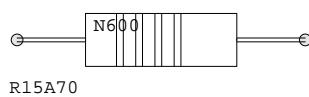
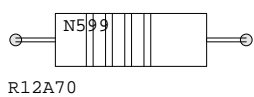
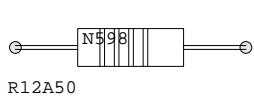

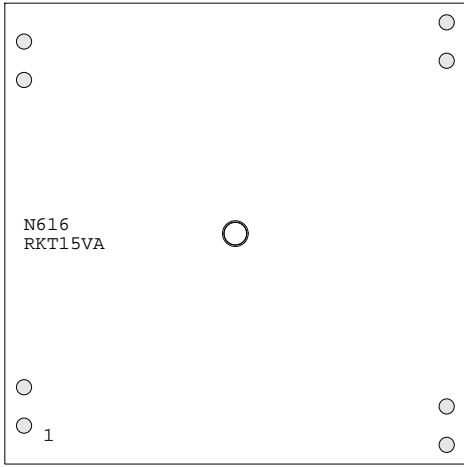

RKT15VA



RS



RTP01



RTP02



RTP03



RTP04

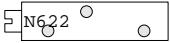

RTP05

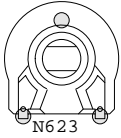

RTP06

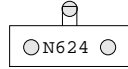

RTP07



RTP08

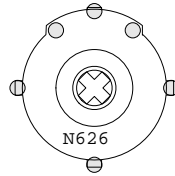

RTP09



RTP10

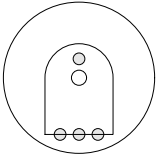

RTP11

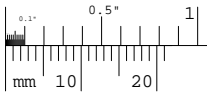

RULER

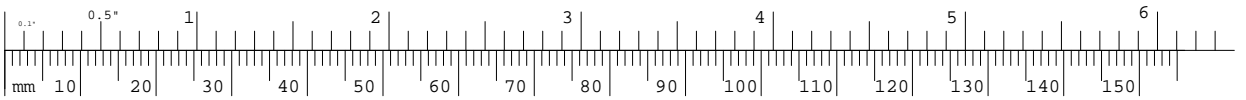

RULERB



S1DILFIX



S1DILO



S1DILS



S2DILFIX



S2DILO



S2DILS

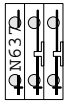

S3DILFIX



S3DILO



S3DILS



S4DILFIX

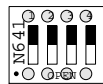

S4DILO



S4DILS

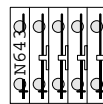

S5DILFIX

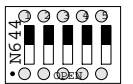

S5DILO

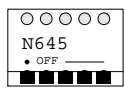

S5DILS

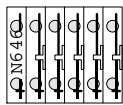

S6DILFIX

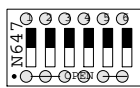

S6DILO

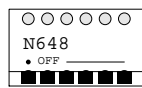

S6DILS

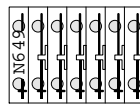

S7DILFIX

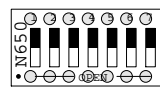

S7DILO

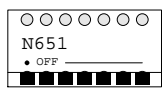

S7DILS

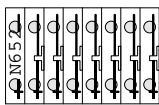

S8DILFIX

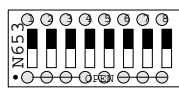

S8DILO

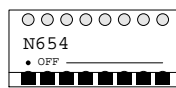

S8DILS

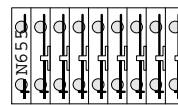

S9DILFIX

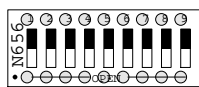

S9DILO

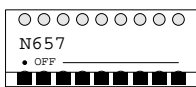

S9DILS

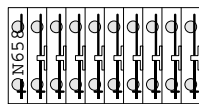

S10DILFIX

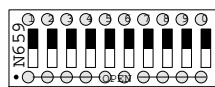

S10DILO

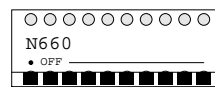

S10DILS

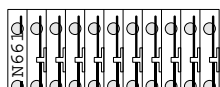

S11DILFIX



S0603



S0805



S0805W



S1005



S1206



S1210



S1210P



S1808



S1808OUTLINE



S1812



S1812OUTLINE



S2220



S2220P



S2221



S2225



S2512



S3225



S4032

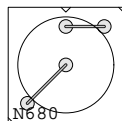

S_MQ6425

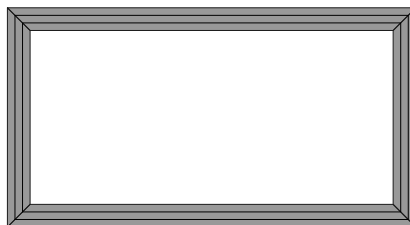

SBOX50X25

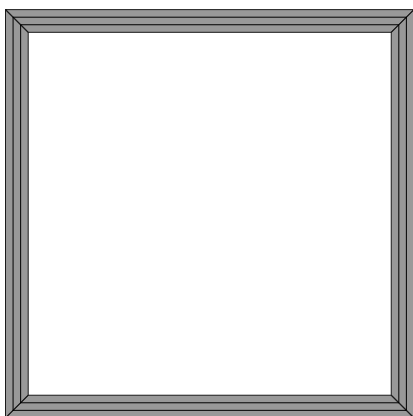

SBOX50X50

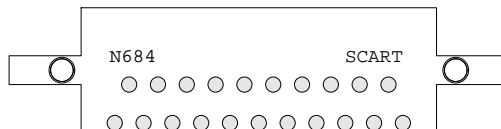

SCARTCON



SCERFILT



SCHRAUBE25



SCHRAUBE30



SCHRAUBE40



SCHRAUBE50



SCREW25



SCREW30



SCREW40



SCREW50



SCREW_M3_CONTACT



SDRSI

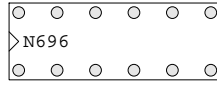

SDSDIL12



SE12

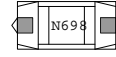

SECLL2

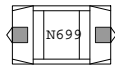
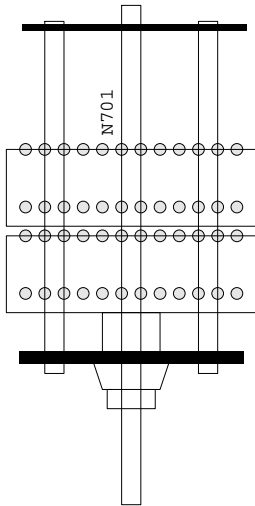

SECLL3



SELKO

SELSBL11

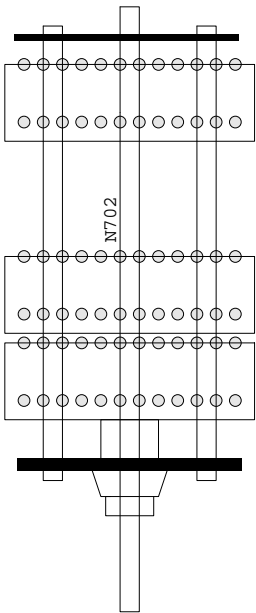

SELSBL12

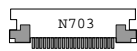

SFV22R



SI



SIL2



SIL3



SIL4

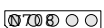

SIL5

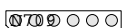

SIL6

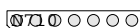

SIL7

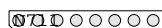

SIL8

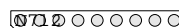

SIL9

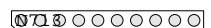

SIL10

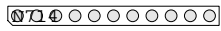

SIL11

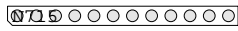

SIL12

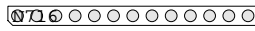

SIL13

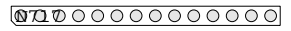

SIL14

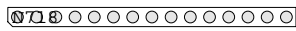

SIL15

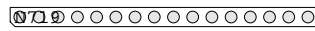

SIL16

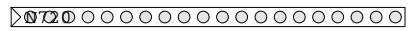

SIL20

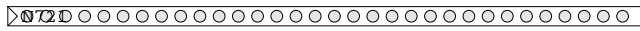

SIL32



SIMID02

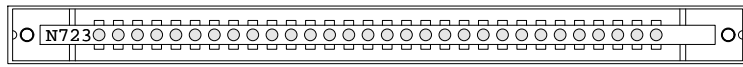

SIP30



SMA_EDGE

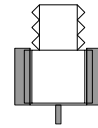

SMA_HS45111



SMA_JS1420711

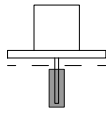

SMACASECON

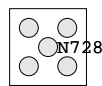

SMACON

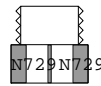

SMASIDECON



SMC



SMD7.3



SMD1206



SMD1210



SMD_JMP1



SMD_JUMP



SMD_LED_B



SMF51COIL



SO60C



SO8



SO8_SLUG



SO8L



SO14



SO14B



SO14L



SO16



SO16_BATWING



SO16L



SO16R



SO16S



SO16W



SO18



SO18L



SO20



SO20L



SO24



SO24_200

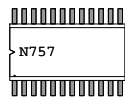

SO24L

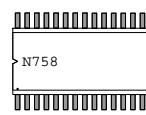

SO28

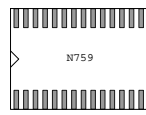

SO28L

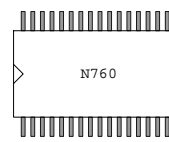

SO32L

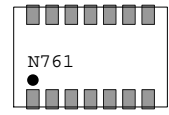

SOBK377

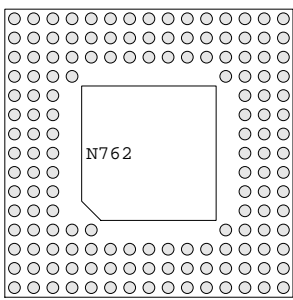

SOCK149



N763
SOD



N764
SOD0



N765
SOD1



N766
SOD2



N767
SOD6



N768
SOD15



N769
SOD28



N770
SOD80



N771
SOD106A



N772
SOD323

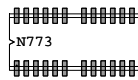

N773
SOJ24_26

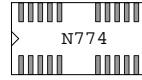

N774
SOJ26



N775
SOJ28_300

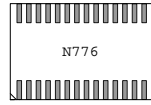

N776
SOJ28_400



N777
SOJ32

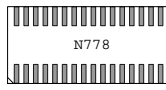

N778
SOJ32_300

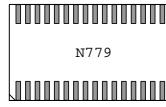

N779
SOJ32_400



N780
SOJ32B

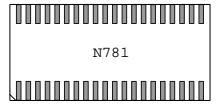

N781
SOJ40_400

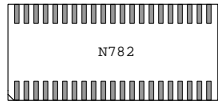

N782
SOJ42_400



N783
SOJ44

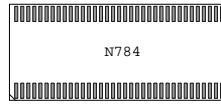

N784
SOJ70_400



N785
SOPOT



N786
SOT1



N787
SOT2



N788
SOT3



N789
SOT14



N790
SOT16



N791
SOT23



N792
SOT23_5



N793
SOT23_6

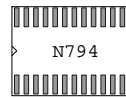

N794
SOT24A

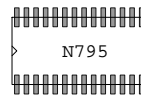

N795
SOT28A



N796
SOT89



N797
SOT143



N798
SOT223



N799
SOT343



N800
SOT363_6



N801
SP



N802
SPD_111



N803
SPIN0



N804
SPL



N805
SQFP32



N806
SQFP48

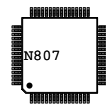

N807
SQFP64

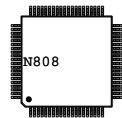

N808
SQFP80



N809
SSOP8



N810
SSOP16I



N811
SSOP20



N812
SSOP20W



N813
SSOP24



N814
SSOP24I



N815
SSOP28



N816
SSOP28EP



N817
SSOP28I



N818
SSOP28S



N819
SSOP28W

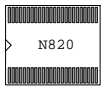

SSOP48

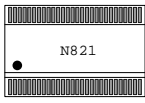

SSOP56



ST4A



ST4B



ST4D



ST4G



ST4H

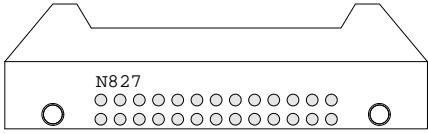

ST26

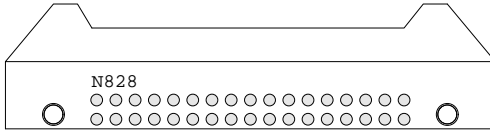

ST34



ST195A



ST195B



ST195D



ST195E



ST195F



ST195G



ST195H



ST293A



ST293B



ST293C



ST293D



ST293E



ST595A



ST595B



ST595C



ST595D



ST595R



ST595T



STP



STRENN

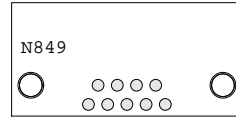

SUBMIND9B

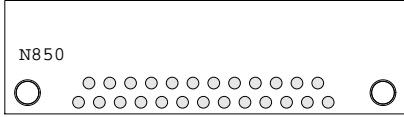

SUBMIND25B

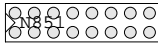

SV16

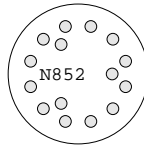

SW3X4

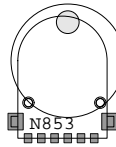

SW_D1511

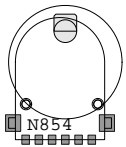

SW_D1511_CORN

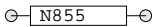

SW_REED

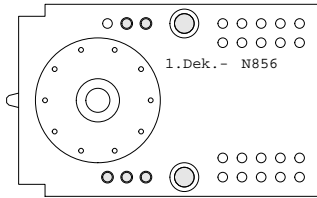

SWCONT06THEX1

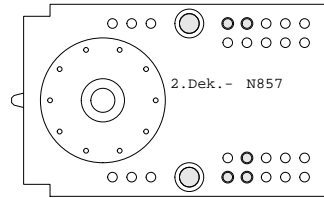

SWCONT06THEX2

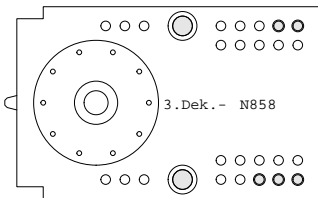

SWCONT06THEX3

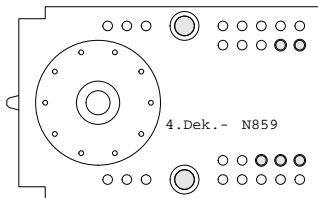

SWCONT06THEX4

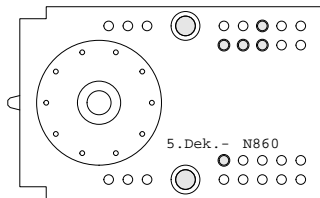

SWCONT06THEX5

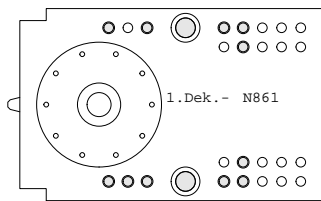

SWCONT10TDEZ1

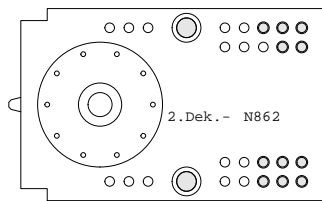

SWCONT10TDEZ2

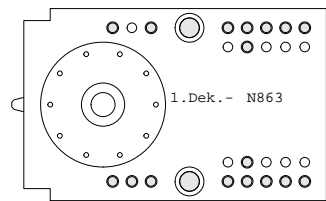

SWCONT16TDEZ1

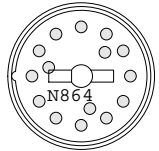

SWSEL01E12S15P



TANTA



TANTB



TANTC



TANTC3



TANTD



TANTD3



TASTLED



TBCE



TDPIN



TEBC



TECHSTD

\$text

TEXT

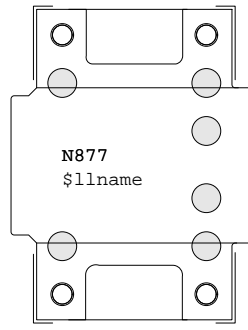

TF_1P2S

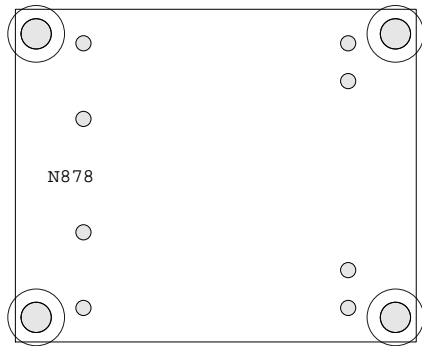

TF_BLOCK_FLX1

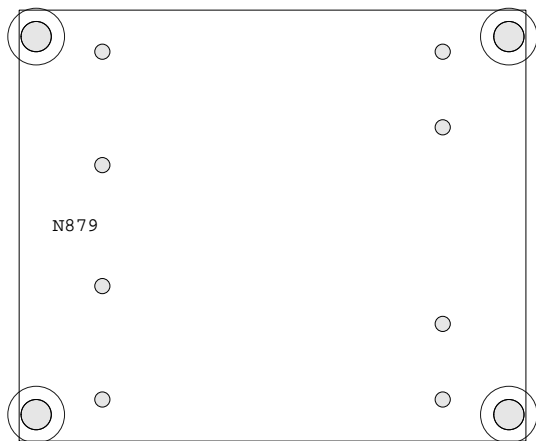

TF_BLOCK_FLX2

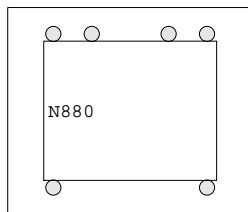

TF_SPN2S_2VA4

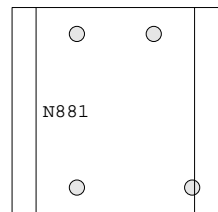

TF_SPN_OVA72

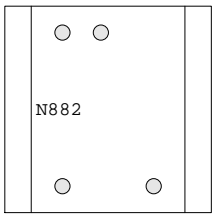

TF_SPN_0VA84

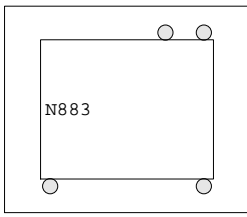

TF_SPN_1VA44

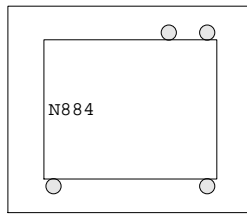

TF_SPN_2VA4



TGLEI0

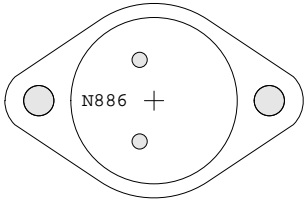

T03

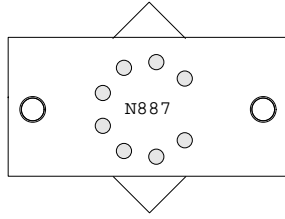

T03_8

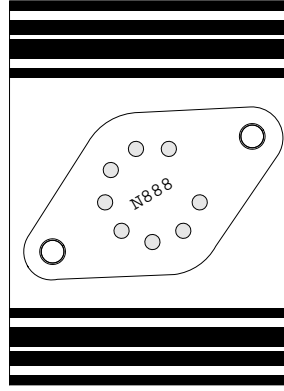

T03_8K

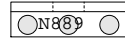

T03PA

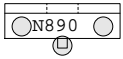

T03PB

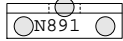

T03PC

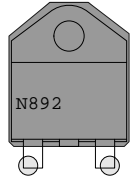

T03PD

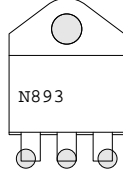

T03PE

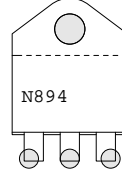

T03PF

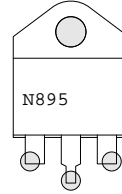

T03PG

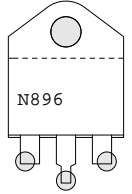

T03PH



T05



T012



T017



T018



T018D



T018P13



T028



T039

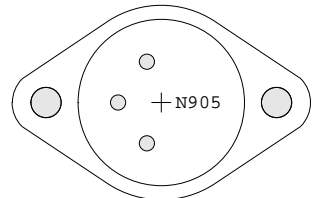

T041



T058

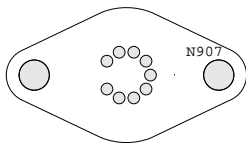

T066_9



T070



T071



T072



T076



T092



T092P13



T092X



T096



T097



T099



T0100



T0100X



T0104



T0105



T0106

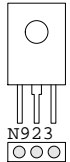

TO126



TO126A



TO126B



TO126C

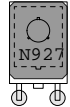

TO126D

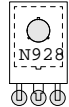

TO126E

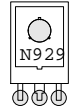

TO126F

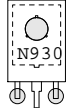

TO126G

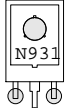

TO126H

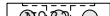

TO127A

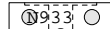

TO127B

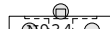

TO127C



TO127D

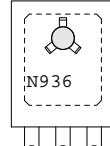

TO127E

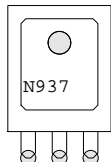

TO127F

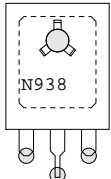

TO127G

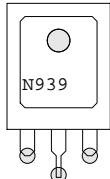

TO127H



TO202_4

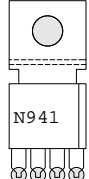

TO202_4E

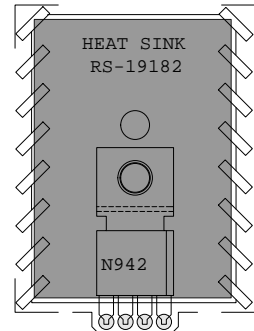

TO202_4G+HS



TO202A



TO202B



TO202C

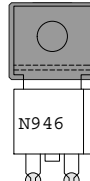

TO202D

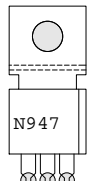

TO202E

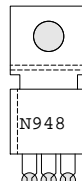

TO202F

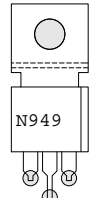

TO202G

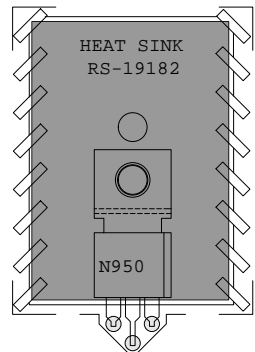

TO202G+HS1

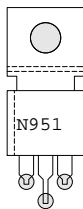

TO202H



TO202S

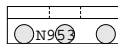

TO218A

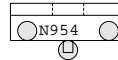

TO218B

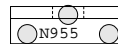

TO218C

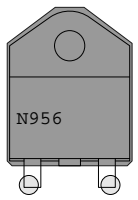

TO218D

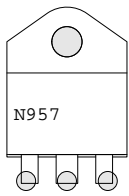

TO218E

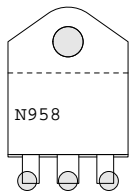

TO218F

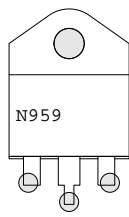

TO218G

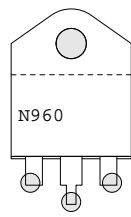

TO218H

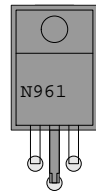

TO220



TO220_5S



TO220A



TO220B



TO220C



TO220D

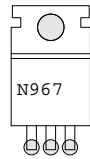

TO220E

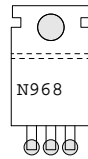

TO220F

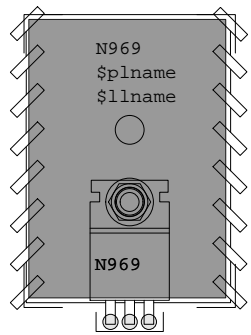

TO220F+HS1

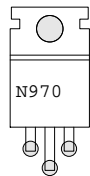

TO220G

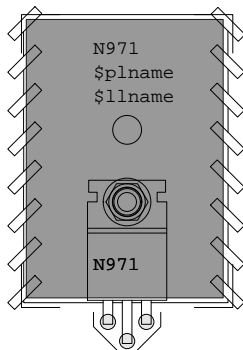

TO220G+HS1

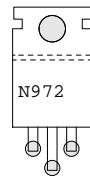

TO220H



TO220KS

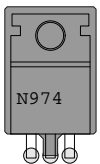

TO220L

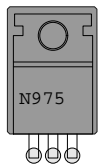

TO220L_1



TO220S

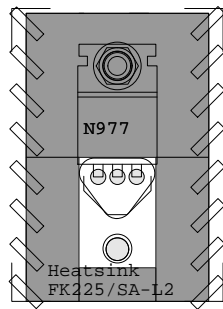

TO220V+HS



TO237

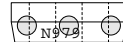

TO247A

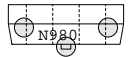

TO247B

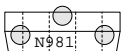

TO247C

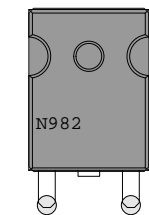

TO247D

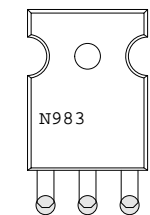

TO247E

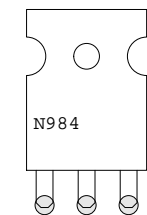

TO247F

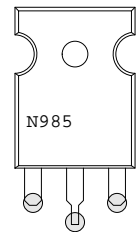

TO247G

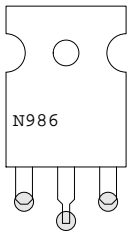

TO247H



TO252

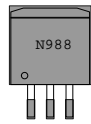

TO263_3

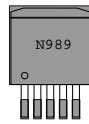

TO263_5



TP



TP3



TPAD



TPC



TPIN



TQFN16

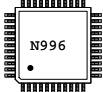

TQFP44

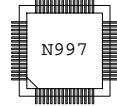

TQFP64

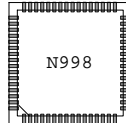

TQFP64_08

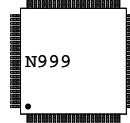

TQFP100

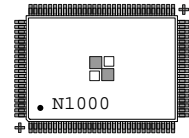

TQFP100RCT

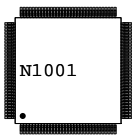

TQFP128

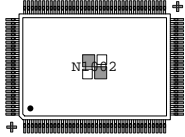

TQFP128RCT

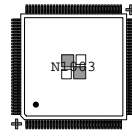

TQFP128S

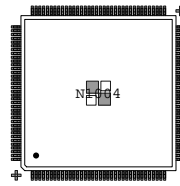

TQFP144

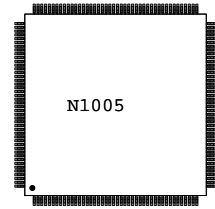

TQFP176

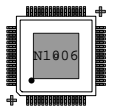

TQFP_RCP64



TR



TR10

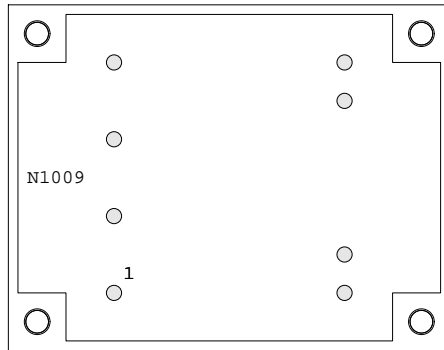

TRAF03VA

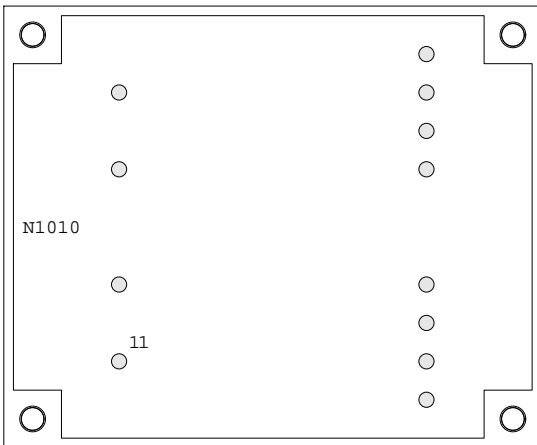

TRAF07VA

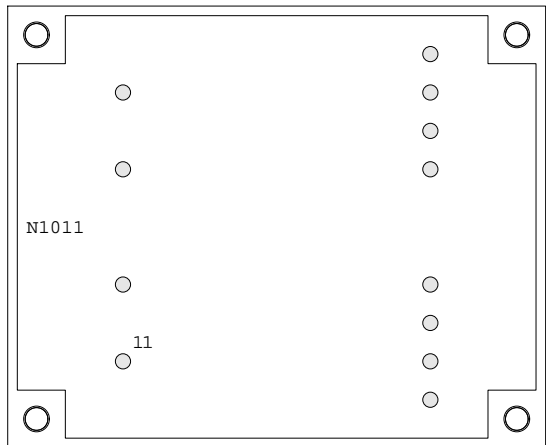

TRAF07VAD

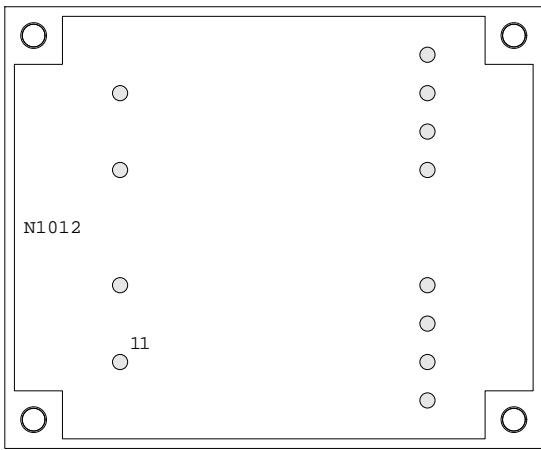

TRAF014VA

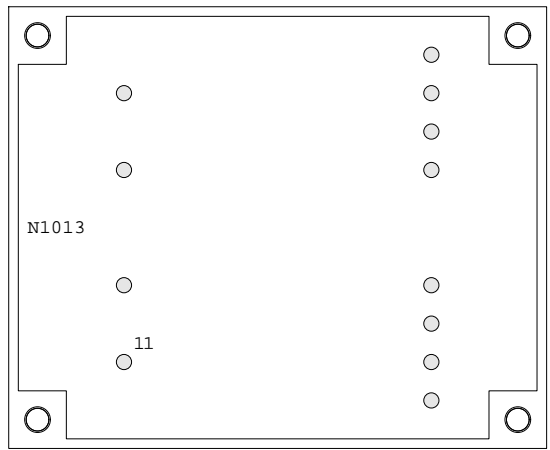

TRAF014VAD

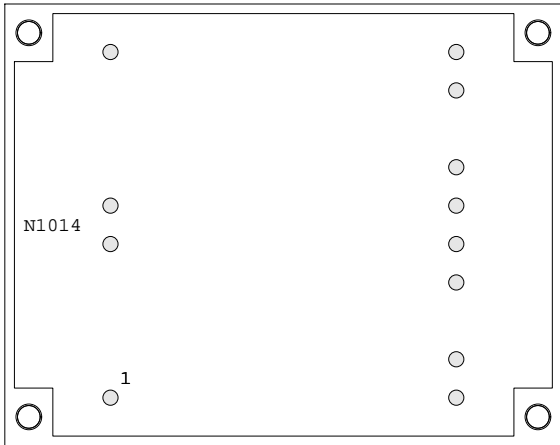

TRAF020VA

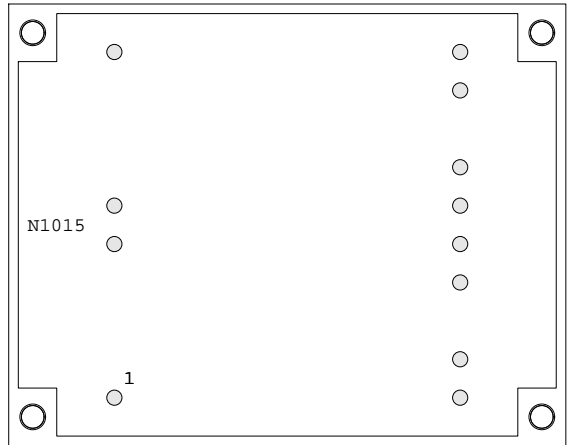

TRAF020VAD

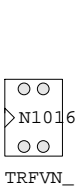

TRFVN_

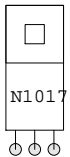

TRIAC



TRIMMC



TRK01



TRK02

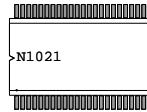

TSOP44

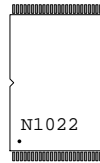

TSOP48S

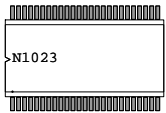

TSOP50

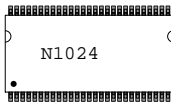

TSOP54

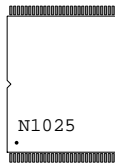

TSOP56S



TSOT23_5



TSOT23_6



TSSOP14



TSSOP14FE



TSSOP16



TSSOP16FE



TSSOP16QS



TSSOP16W



TSSOP20



TSSOP20FE



TSSOP28

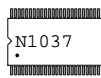

TSSOP48

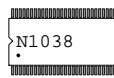

TSSOP56

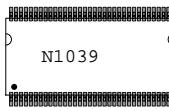

TSSOP66



U78LXX

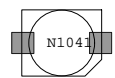

UP2

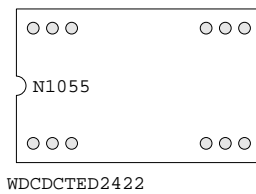
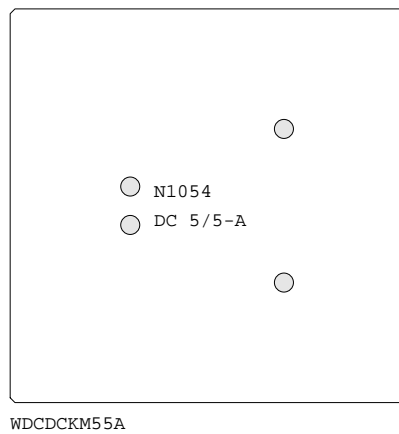
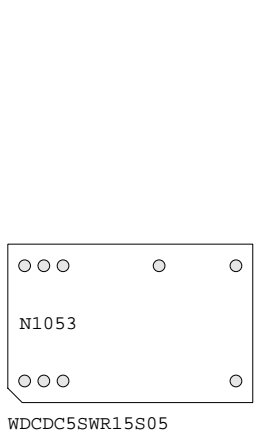
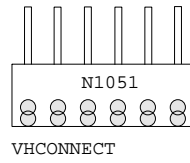
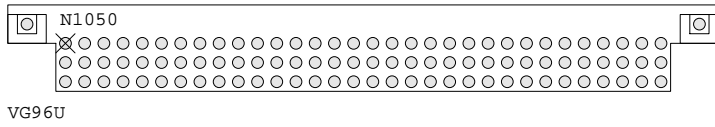
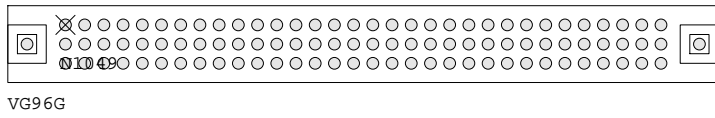
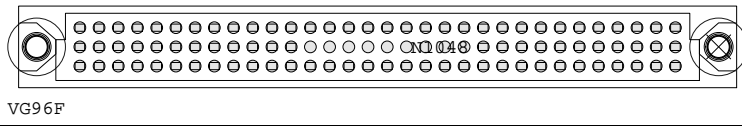
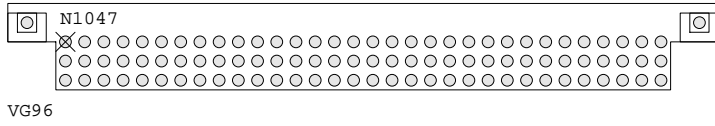
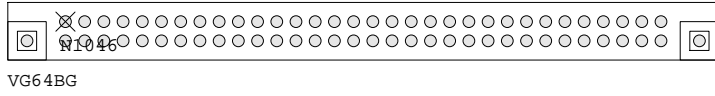
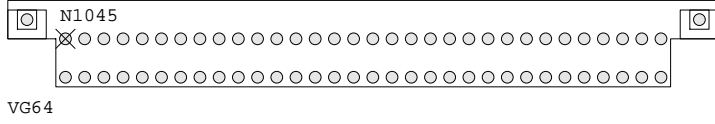
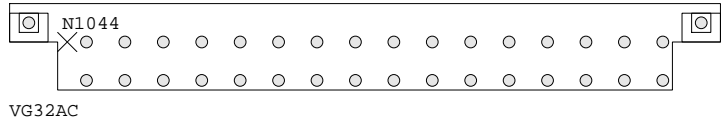
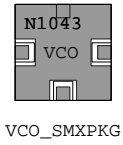
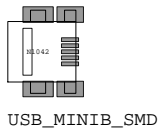

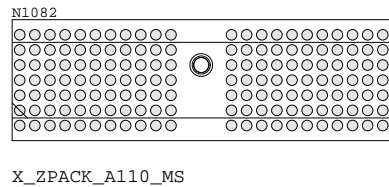
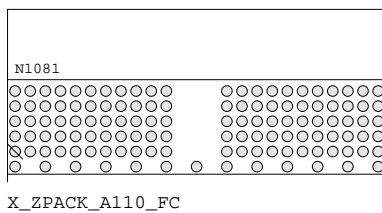
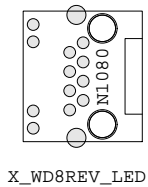
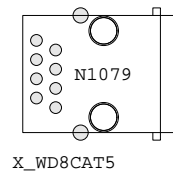
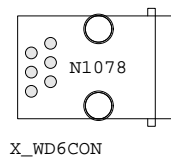
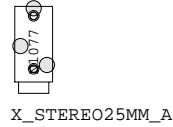
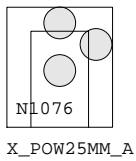
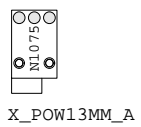
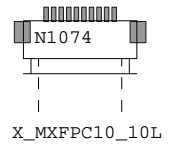
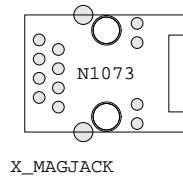
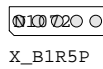
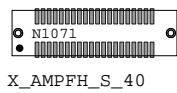
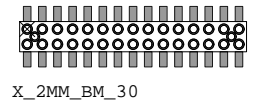
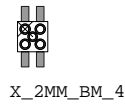
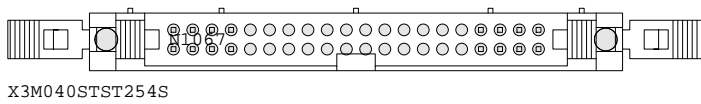
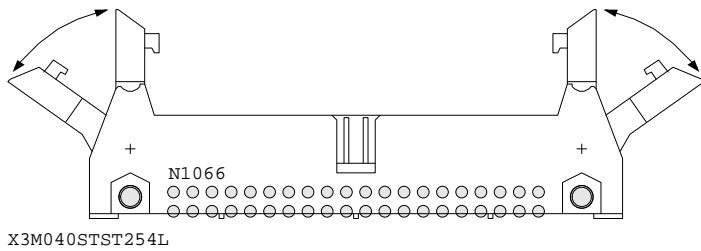
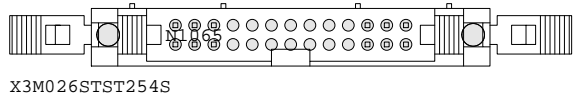
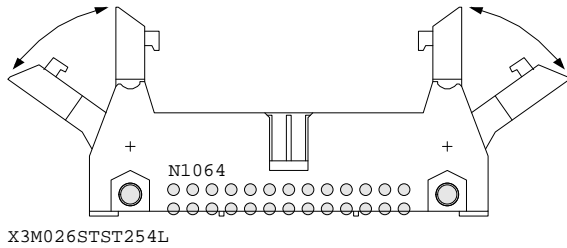
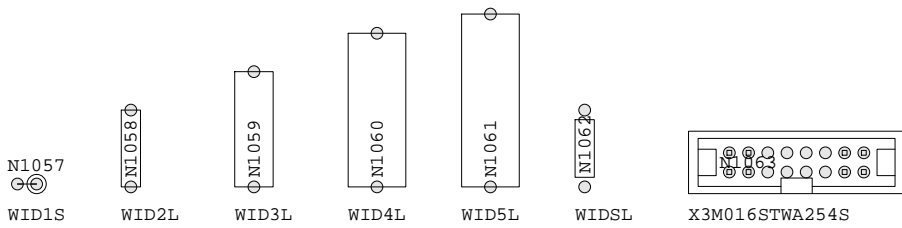

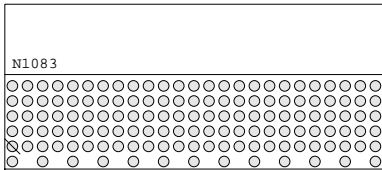

X_ZPACK_B125_FC

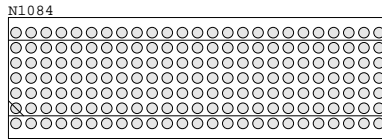

X_ZPACK_B125_MS

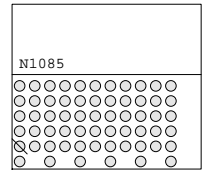

X_ZPACK_C55_FC

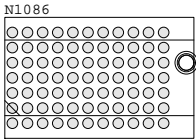

X_ZPACK_C55_MS

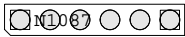

XAMP06BUST396S

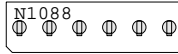

XAMP06STST396S

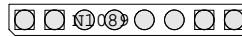

XAMP08BUST396S



XAMP08STST396S



XB1R2PS



XB1R3PS



XB1R4PS



XB1R5PS



XB1R6PS

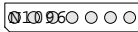

XB1R7PS

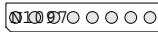

XB1R8PS

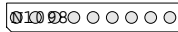

XB1R9PS

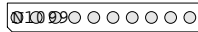

XB1R10PS

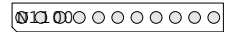

XB1R11PS

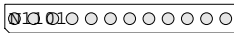

XB1R12PS

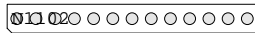

XB1R13PS

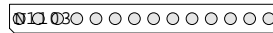

XB1R14PS

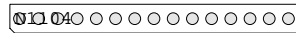

XB1R15PS

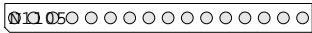

XB1R16PS

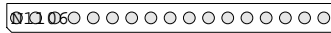

XB1R17PS

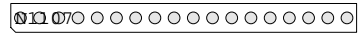

XB1R18PS

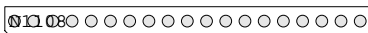

XB1R19PS

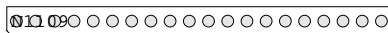

XB1R20PS



XB2R4PS



XB2R6PS



XB2R8PS

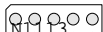

XB2R10PS

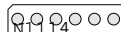

XB2R12PS

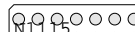

XB2R14PS

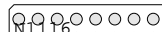

XB2R16PS

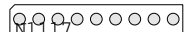

XB2R18PS

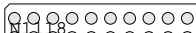

XB2R20PS

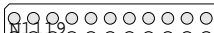

XB2R22PS

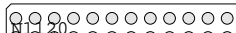

XB2R24PS

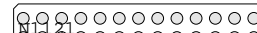

XB2R26PS

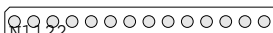

XB2R28PS

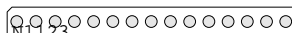

XB2R30PS

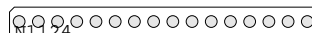

XB2R32PS

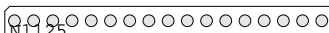

XB2R34PS

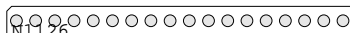

XB2R36PS

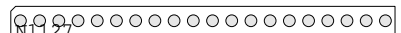

XB2R40PS

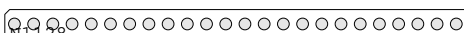

XB2R48PS

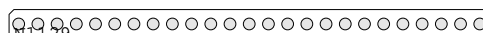

XB2R50PS

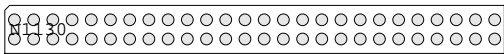

XB2R52PS

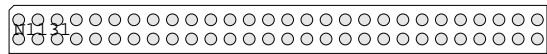

XB2R56PS

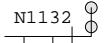

XBAT



XERNISMC26SD



XERNISMC50SD

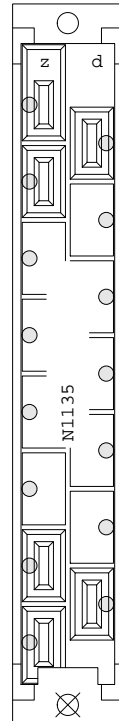

XFEDERL15DZ

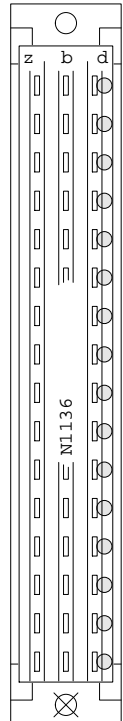

XFEDERL16D13

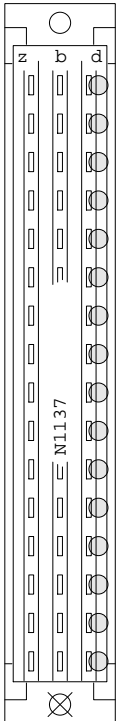

XFEDERL16D16



XFEDERL32BZ

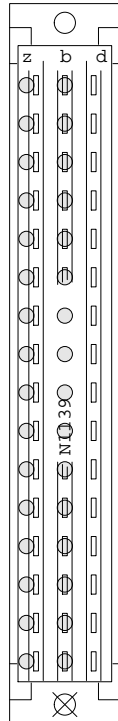

XFEDERL32BZ13

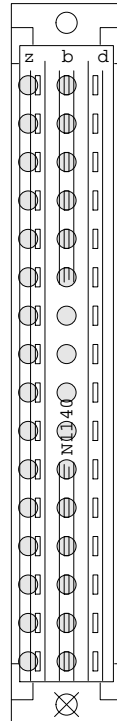

XFEDERL32BZ16

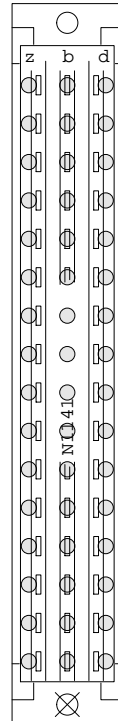

XFEDERL48DBZ13

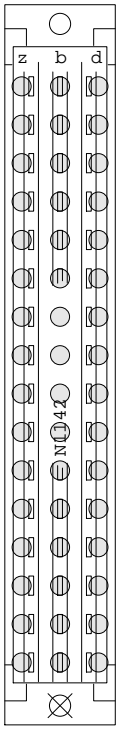

XFEDERL48DBZ16

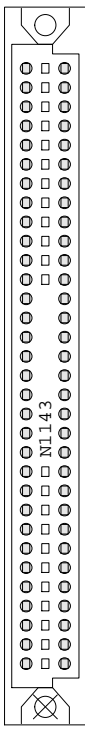

XFEDERL64AC08

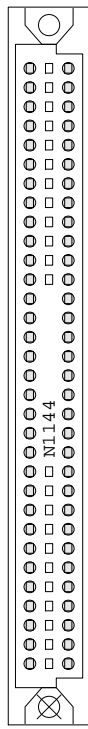

XFEDERL64AC10

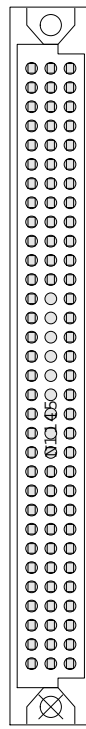

XFEDERL96ABC08

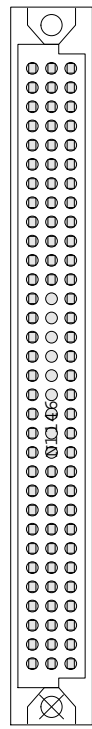

XFEDERL96ABC10



XFLSTKML

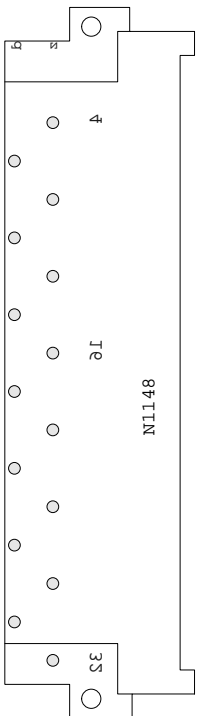

XML15DZ

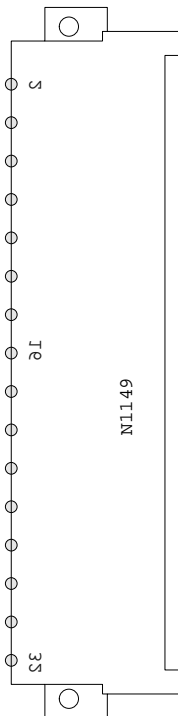

XML16D

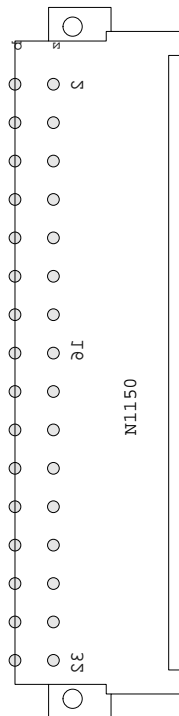

XML32BZ

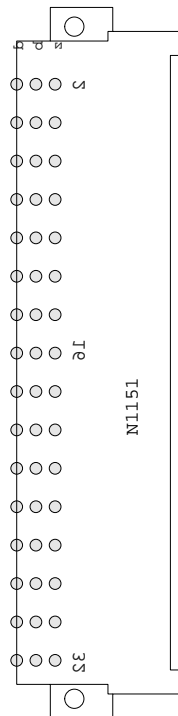

XML48DBZ

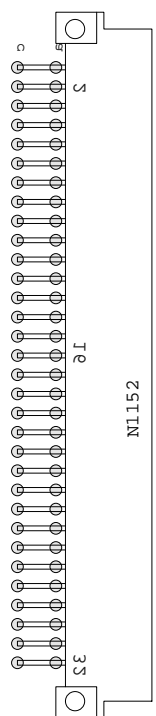

XML64AC

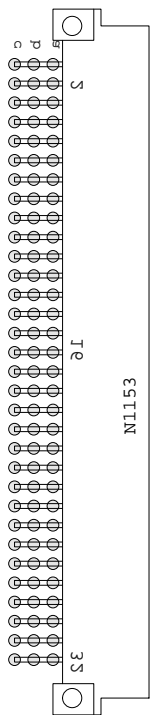

XML96ABC



XPCS2X18P



XPCS2X31P

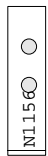

XPHOE1SCHR500L



XPHOE1SCHR500LZ

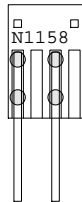

XPHOE2FLST500L

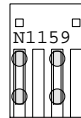

XPHOE2FLST500S



XPHOE2SCHR508S

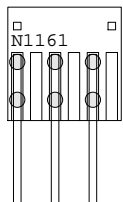

XPHOE3FLST500L

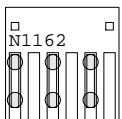

XPHOE3FLST500S

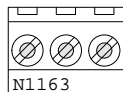

XPHOE3SCHR508S

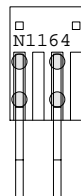

XPHOE4FLST500W

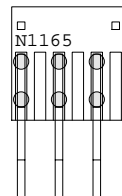

XPHOE6FLST500W

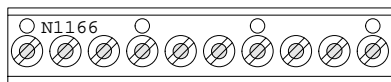

XPHOE10SCHR508S



XS1R2PS



XS1R3PS



XS1R4PS

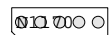

XS1R5PS

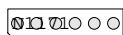

XS1R6PS

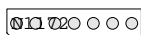

XS1R7PS

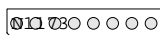

XS1R8PS

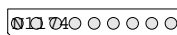

XS1R9PS

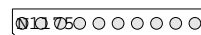

XS1R10PS

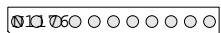

XS1R11PS

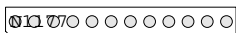

XS1R12PS

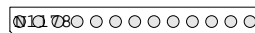

XS1R13PS

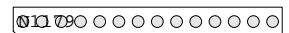

XS1R14PS



XS1R15PS

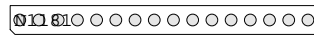

XS1R16PS



XS1R17PS



XS1R18PS



XS1R19PS

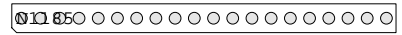

XS1R20PS



XS2R4PS



XS2R6PS



XS2R8PS

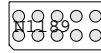

XS2R10PS

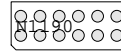

XS2R12PS

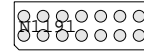

XS2R14PS

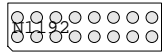

XS2R16PS

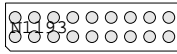

XS2R18PS

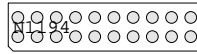

XS2R20PS

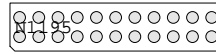

XS2R22PS



XS2R24PS



XS2R26PS



XS2R28PS



XS2R30PS

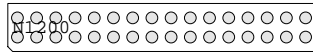

XS2R32PS

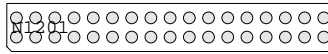

XS2R34PS

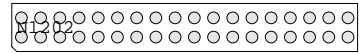

XS2R36PS

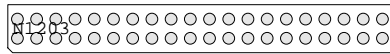

XS2R40PS

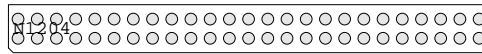

XS2R50PS



XS2R52PS



XS2R56PS

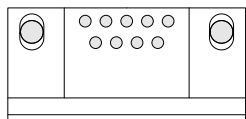

N1207

XSUBD9BL

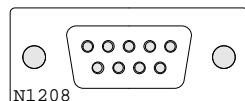

N1208

XSUBD9BS

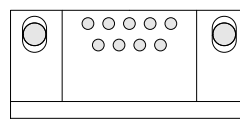

N1209

XSUBD9SL

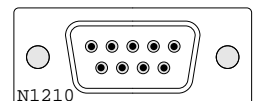

N1210

XSUBD9SS

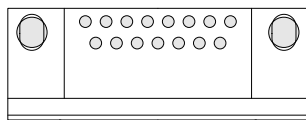

N1211

XSUBD15BL

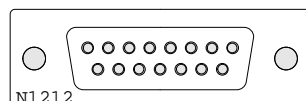

N1212

XSUBD15BS

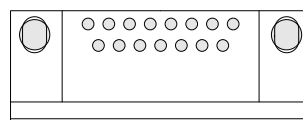

N1213

XSUBD15SL

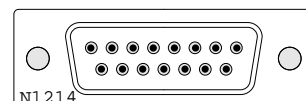

N1214

XSUBD15SS

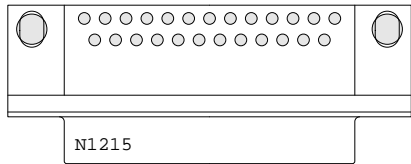

XSUBD25BL

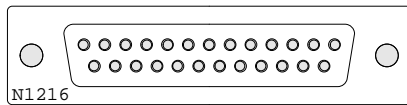

XSUBD25BS

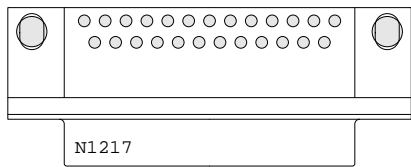

XSUBD25SL

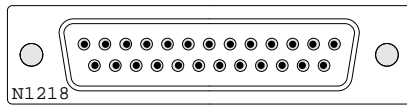

XSUBD25SS

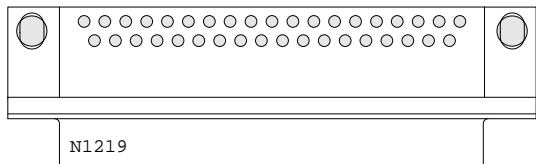

XSUBD37BL

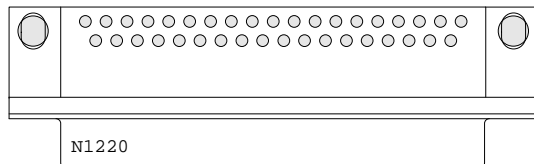

XSUBD37SL

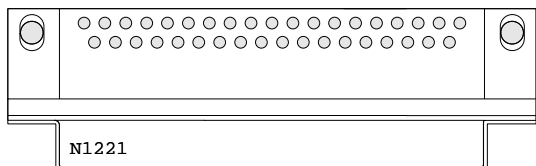

XSUBD37SR

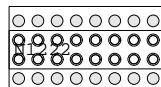

XT2R16PS

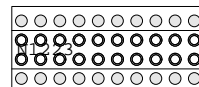

XT2R20PS



XT01

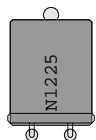

XT02

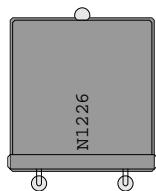

XT03



XT04



XT04_1



XT05

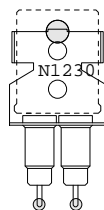

XT06



XT07

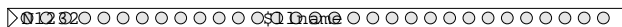

XTCON

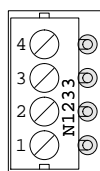

XTERM4P

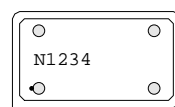

XTG4P

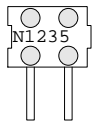

XVOGE2FLST500L



XVOGE2FLST500S

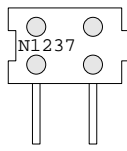

XVOGE2FLST750L

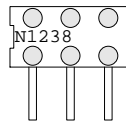

XVOGE3FLST500L

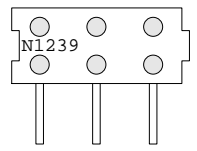

XVOGE3FLST750L



XWAGO2SCHR500S



XWAGO2SCHR508S

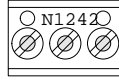

XWAGO3SCHR500S

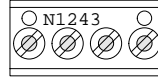

XWAGO4SCHR508S

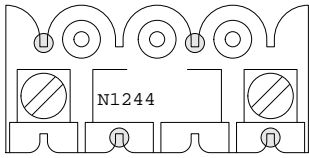

XWAGO4SCHR1000

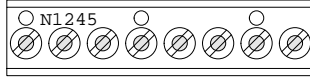

XWAGO8SCHR508S

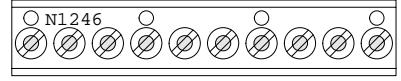

XWAGO10SCHR508S

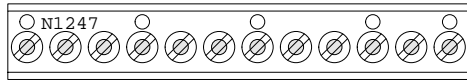

XWAGO12SCHR508S



ZDIO0D



ZDIO0L



ZDIO1L



ZDIO2L

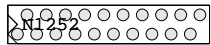

ZIP20

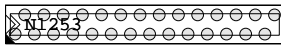

ZIP28



ZRES

Alle Rechte vorbehalten. Proprietary data, company confidential. All rights reserved. Confie a titre de secret d'entreprise. Tous droits réservés. Comunicado como secreto empresarial. Reservados todos os direitos. Confiable como secreto industrial. Reservados todos los derechos.

Apertures		Gerber D-Code	Traces		Pads	
Draw Symbols	Flash Symb.		mm	mil	mm	mil
	.	D10	0.051	2	0.076	3
	. .	D11	0.254	10	0.254	10
	. . .	D12	0.305	12	0.305	12
	D13	0.406	16	0.406	16
	D14	0.508	20	0.508	20
	D15	0.635	25	0.635	25
	D16	0.812	32	0.812	32
	D17	1.016	40	1.016	40
	D18	1.270	50	1.270	50
	D19	1.549	61	1.549	61
	D70	1.778	70	1.778	70
	○	D71			2.007	79
	●	konstr.			2.307	
	●	D20	2.515	99	2.515	99
	●	konstr.			2.600	
	●	konstr.			2.815	
	●	konstr.			2.900	
	●	konstr.			3.000	
	●	konstr.			3.300	
	●	konstr.			3.500	
	●	D21			3.810	150
	●	konstr.			4.000	
	●	konstr.			4.110	
	●	konstr.			4.300	
	●	konstr.			4.800	
	●	konstr.			5.000	
	●	konstr.			5.300	
	.	D22			0.152	6
	.	D23			0.305	12
	.	D24			0.508	20
	.	D25			0.635	25
	.	D26			0.812	32
	.	D27			1.016	40
	.	D28			1.270	50
	.	D29			1.549	61
	.	D72			1.778	70
	■	konstr.			2.078	
	■	D73			2.515	99
	■	konstr.			2.815	

Typ		Verwendung	Teil	Ind.	Änderung		Veranlassung	Durchführung	Freigabeerford.	Ausgabedatum	Name
Oberflächenbehandlung		Maßstab	Fertigungs-Toleranz	Nichtbemaßte Radian							
Entworfen		Datum	Werkstoff		Schwindung x= % y= % z= %		Oliver Bartels F+E Ottostr. 3 D-85435 Erding Tel. (08122) 9729-0 Fax. (08122) 9729-10				
		Ferranti									
		Aperture Table		Ersatz für							

19Zoll Baugruppen-Traeger BUS - Leiterkarte

lp_bgt19z84te3he

84TE x 3HE

Bemassung BESTUECKUNG
 LOESEITIG TEILESEITE

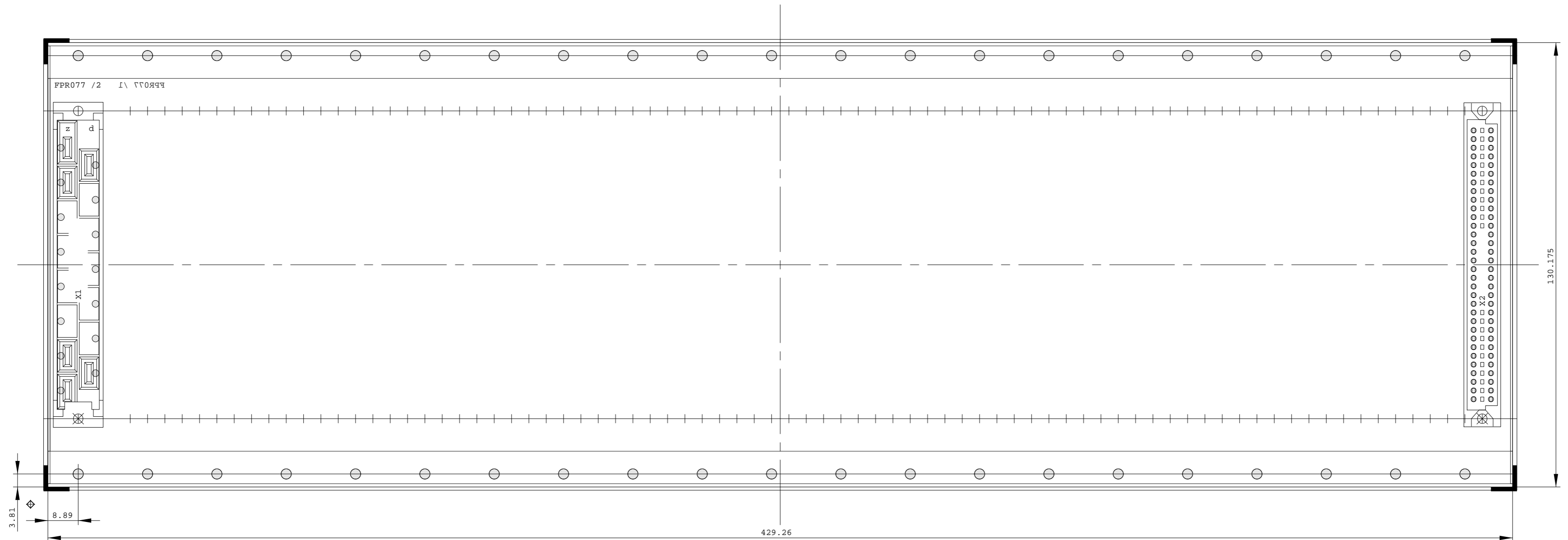

Typ	Verwendung	Teil	Ind.	Änderung		Veran- lassung	Durch- führung	Freigabe- erford.	Ausgabe- datum	Name
										Ja Nein
										Ja Nein
										Ja Nein
										Ja Nein
										Ja Nein
										Ja Nein
										Ja Nein
										Ja Nein
Oberfl.,chenbehandlung		Maßstab	Fertigungs- Toleranz	Nichtbemaßte Radien		 Oliver Bartels F+E Ottostr. 3 D-85435 Erding Tel. (08122) 9729-0 Fax. (08122) 9729-10				
Entworfen	Datum									Ersatz für
Auslieferndes Werk		Bartels AutoEngineer								

Diese Zeichnung nur in CAD ändern!

Alle Betriebsmittel anvertraut. Alle Rechte vorbehalten.
 Proprietary data, company confidential. All rights reserved.
 Confie a titre de secret d'entreprise. Tous droits réservés.
 Comunicado como secreto empresarial. Reservados todos os direitos.
 Confiado como secreto industrial. Reservados todos los derechos.

HF-Gehäuse - Karte

158 x 64mm

Bemassung BESTUECKUNG
 ETIETEOI TEILESEITE



EB5011 \ T
 FPR077 / 2

Typ	Verwendung	Teil	Ind.	Änderung		Veran- lassung	Durch- föhrung	Freigabe- erford.	Ausgabe- datum	Name
										Ja / Nein
										Ja / Nein
										Ja / Nein
										Ja / Nein
										Ja / Nein
										Ja / Nein
Oberflächenbehandlung		Maßstab	Fertigungs- Toleranz	Nichtbemaßte Radien		Oliver Bartels F+E Ottostr. 3 D-85435 Erding Tel. (08122) 9729-0 Fax. (08122) 9729-10				
			Werkstoff	Schwindung						
				x=	‰	x= ‰ y= ‰ z= ‰				
Entworfen	Datum									
Ersatz für										

Auslieferndes
 Werk

Änderungen nur im CAD-System!

Alle Betriebsmittel anvertraut. Alle Rechte vorbehalten.
 Proprietary data, company confidential. All rights reserved.
 Confie a titre de secret d'entreprise. Tous droits réservés.
 Comunicado como secreto empresarial. Reservados todos los derechos.
 Confiado como secreto industrial. Reservados todos los derechos.

Optibox 5000 Knuerr

155 x 247mm

Bemassung
 ЛОТІЄТІЄОІ

BESTUECKUNG
 ТІІІІЄЄІТІЄ

EBB011 \ J
 FPR077 / 2

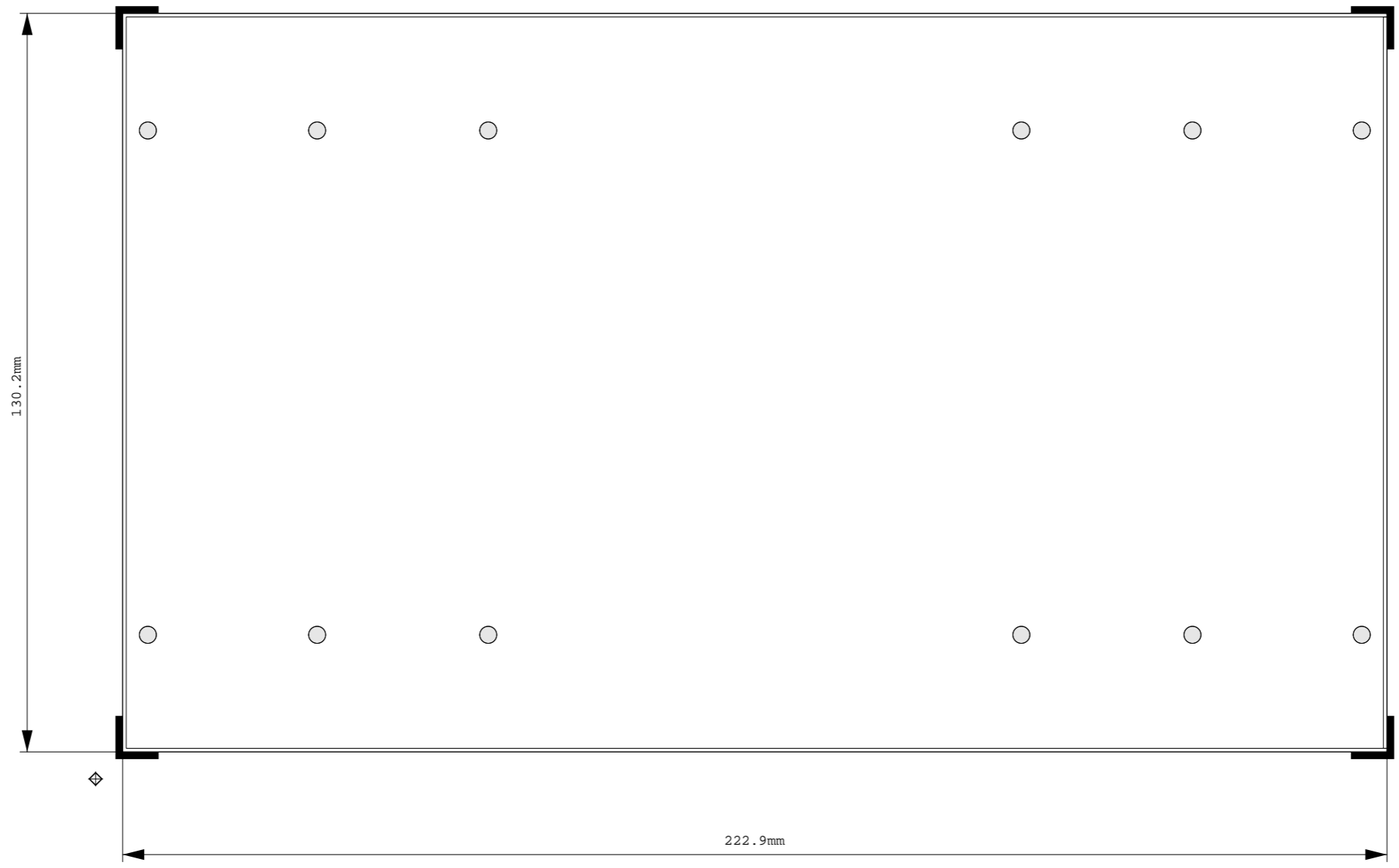

Typ	Verwendung	Teil	Ind.	Änderung	Veran-lassung	Durch-führung	Freigabe-erford.	Ausgabe-datum	Name
									Ja / Nein
									Ja / Nein
									Ja / Nein
									Ja / Nein
									Ja / Nein
									Ja / Nein
									Ja / Nein
									Ja / Nein
									Ja / Nein
									Ja / Nein

Oberflächenbehandlung		Maßstab	Fertigungs-Toleranz	Nichtbemaßte Radian			Oliver Bartels F+E Ottostr. 3 D-85435 Erding Tel. (08122) 9729-0 Fax. (08122) 9729-10
			Werkstoff	Schwindung x= % y= % z= %			
Entworfen	Datum						
Ersatz für							

Auslieferndes
 Werk

Änderungen nur im CAD-System!

Alle Betriebsmittel anvertraut. Alle Rechte vorbehalten.
 Proprietary data, company confidential. All rights reserved.
 Confie a titre de secret d'entreprise. Tous droits réservés.
 Comunicado como secreto empresarial. Reservados todos los derechos.
 Confiado como secreto industrial. Reservados todos los derechos.

PC - Slot - Karte

Bemassung

BESTUECKUNG

ETIESTEOL

TEILESEITE

337.82

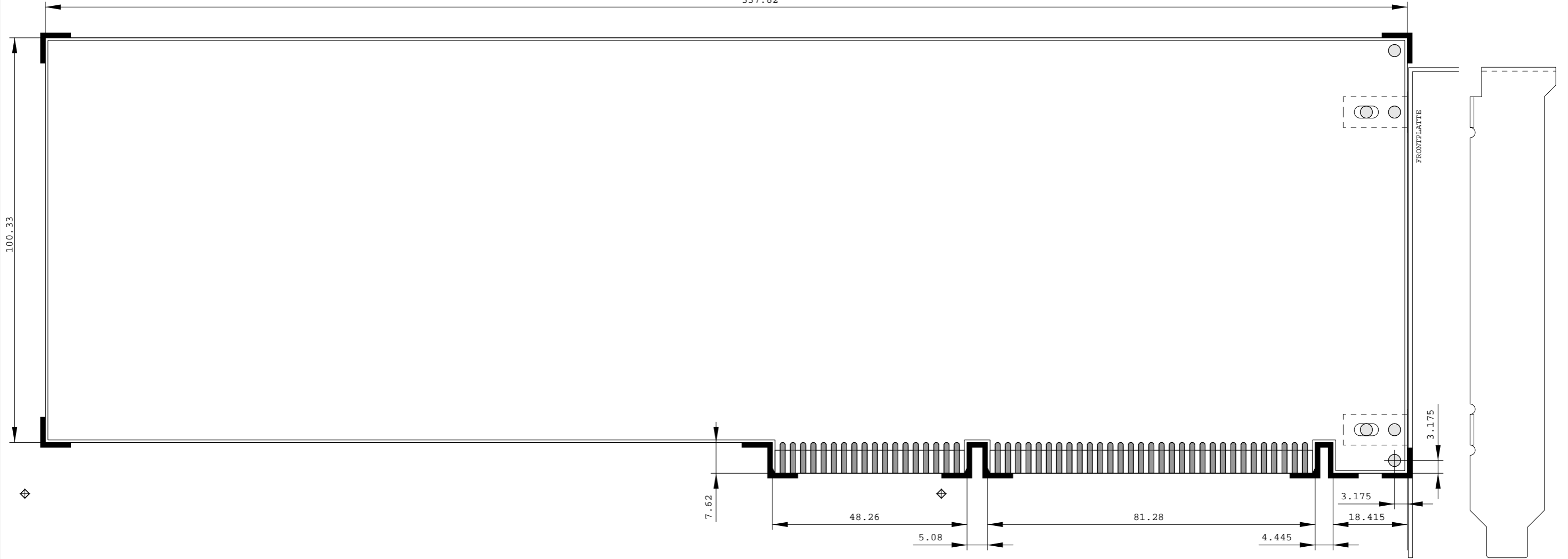

Typ	Verwendung	Teil	Ind.	Änderung	Veran- lassung	Durch- füh- rung	Freigabe- erford.	Ausgabe- datum	Name
									Ja / Nein
									Ja / Nein
									Ja / Nein
									Ja / Nein
									Ja / Nein
									Ja / Nein
									Ja / Nein

Oberflächenbehandlung		Maßstab	Fertigungs- Toleranz	Nichtbemaßte Radien			Oliver Bartels F+E Ottostr. 3 D-85435 Erding Tel. (08122) 9729-0 Fax. (08122) 9729-10
Entworfen			Werkstoff				
Datum							Ersatz für

Auslieferndes
Werk

Bartels AutoEngineer A3BLATT

Änderungen nur im CAD-System!

Alle Rechte vorbehalten. Alle Rechte vorbehalten.
 Proprietary data, company confidential. All rights reserved.
 Confie a titre de secret d'entreprise. Tous droits réservés.
 Comunicado como secreto empresarial. Reservados todos os direitos.
 Confialdo como secreto industrial. Reservados todos los derechos.

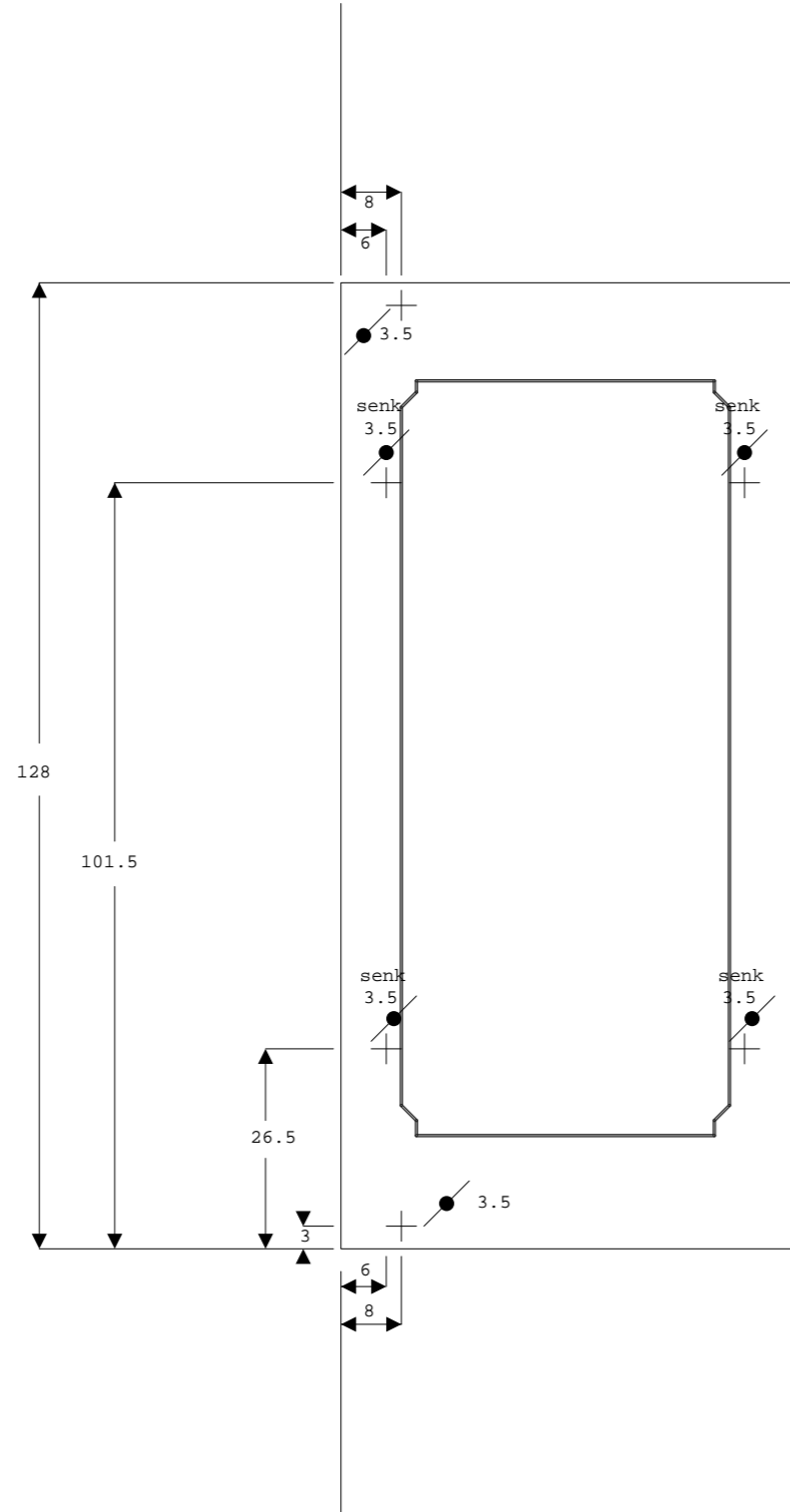

Typ	Verwendung	Teil	Ind.	Änderung		Veran-lassung	Durch-führung	Freigabe-erford.	Ausgabe-datum	Name
								Ja	Nein	
								Ja	Nein	
								Ja	Nein	
								Ja	Nein	
								Ja	Nein	
								Ja	Nein	
								Ja	Nein	
								Ja	Nein	
								Ja	Nein	
Oberfl,chenbehandlung		Maßstab	Fertigungs-Toleranz	Nichtbemaßte Radien		 Oliver Bartels F+E Ottostr. 3 D-85435 Erding Tel. (08122) 9729-0 Fax. (08122) 9729-10				
			Werkstoff	Schwindung <div style="display: flex; flex-direction: column; align-items: center;"> <div style="display: flex; align-items: center; margin-bottom: 2px;"> x= ‰ </div> <div style="display: flex; align-items: center; margin-bottom: 2px;"> y= ‰ </div> <div style="display: flex; align-items: center;"> z= ‰ </div> <div style="text-align: center; margin-top: 2px;"> </div> </div>						
Entworfen	Datum	Panel 12TE		Ersatz für						

Auslieferndes Werk



Bartels AutoEngineer A3BLATT

Änderungen nur im CAD-System!

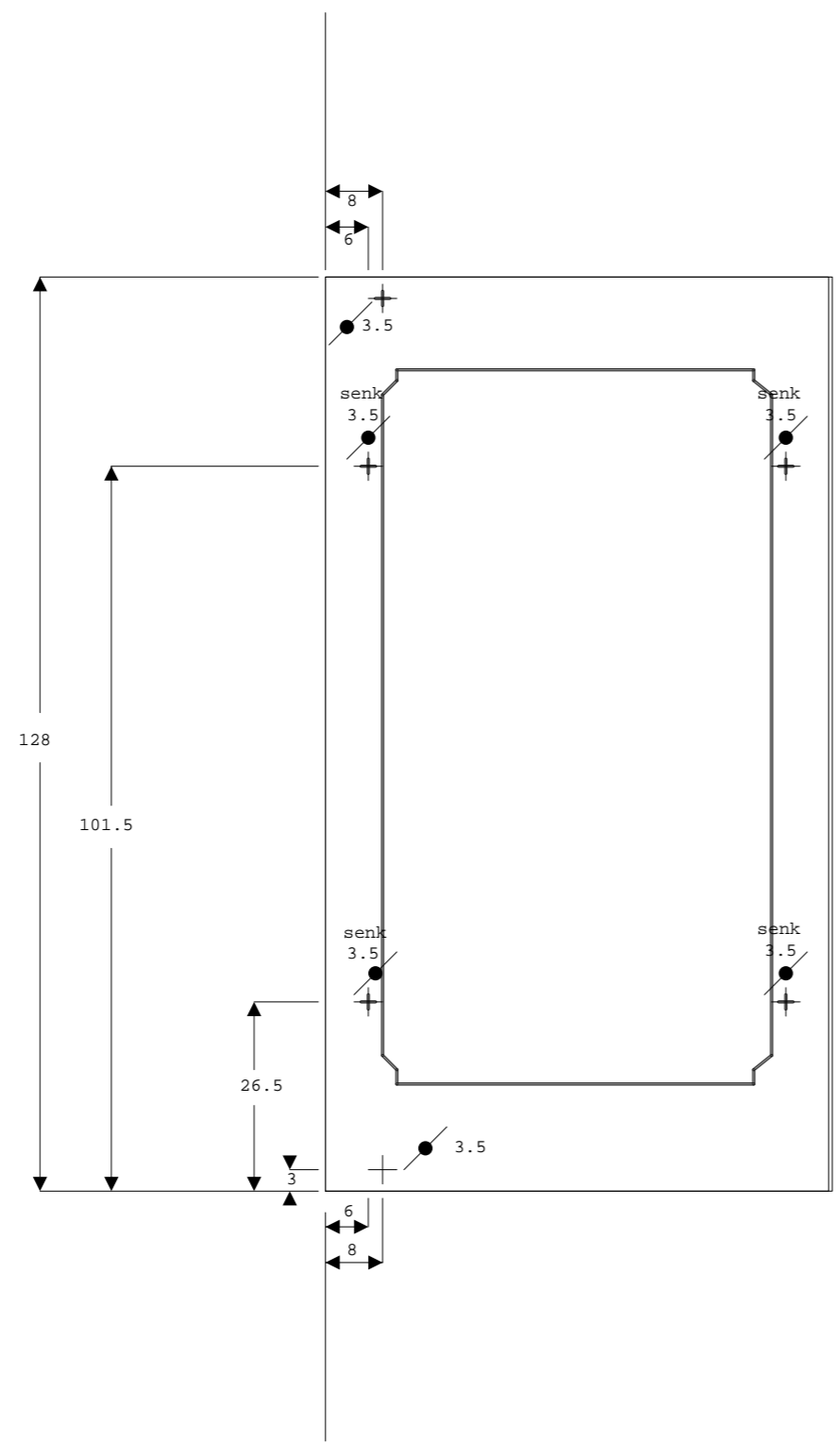
Alle Rechte vorbehalten. Alle Rechte vorbehalten.
 Proprietary data, company confidential. All rights reserved.
 Confie a titre de secret d'entreprise. Tous droits réservés.
 Comunicado como secreto empresarial. Reservados todos os direitos.
 Confiable como secreto industrial. Reservados todos los derechos.



Typ	Verwendung	Teil	Ind.	Änderung			Veran- lassung	Durch- führung	Freigabe- erford.	Ausgabe- datum	Name
											Ja / Nein
											Ja / Nein
											Ja / Nein
											Ja / Nein
											Ja / Nein
											Ja / Nein
											Ja / Nein
											Ja / Nein
											Ja / Nein
											Ja / Nein
											Ja / Nein

Oberflächenbehandlung		Maßstab	Fertigungs- Toleranz	Nichtbeaütete Radien		 Oliver Bartels F+E Ottostr. 3 D-85435 Erding Tel. (08122) 9729-0 Fax. (08122) 9729-10
			Werkstoff	Schwindung		
Entworfen	Datum			x= %	y= %	
				z= %		
Panel 14TE					Ersatz für	

Änderungen nur im CAD-System!

Alle Rechte vorbehalten. Alle Rechte vorbehalten. All rights reserved. All rights reserved. Tous droits réservés. Tous droits réservés. Comúnio como secreto empresarial. Reservados todos los derechos. Reservados todos los derechos. Reservados todos los derechos.

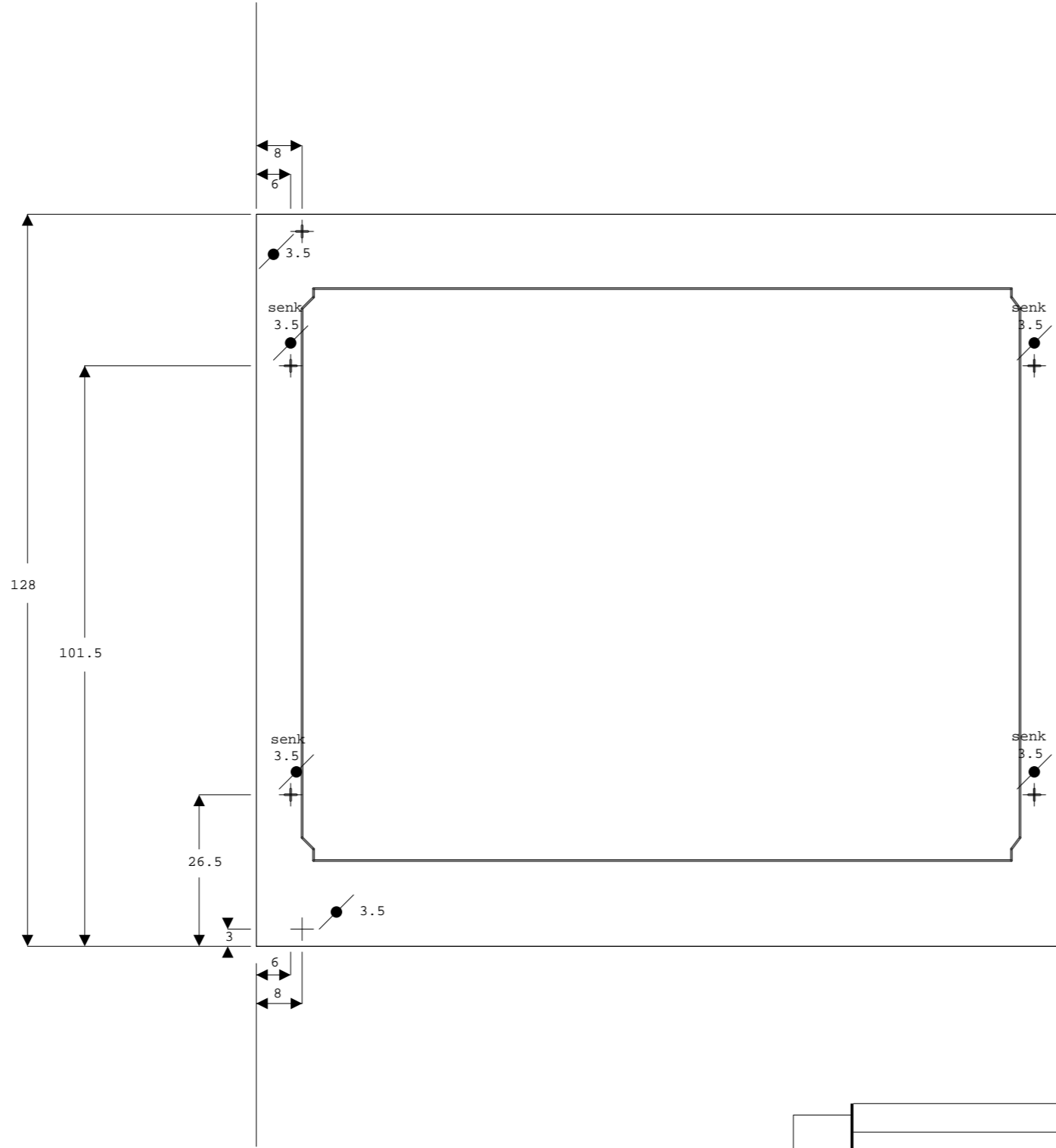

Typ	Verwendung	Teil	Ind.	Änderung	Veran- lassung	Durch- führung	Freigabe- erford.	Ausgabe- datum	Name
									Ja / Nein
									Ja / Nein
									Ja / Nein
									Ja / Nein
									Ja / Nein
									Ja / Nein

Oberflächenbehandlung		Maßstab	Fertigungs- Toleranz	Nichtbemaßte Radien	x = $\frac{1}{4}$ y = $\frac{1}{4}$ z = $\frac{1}{4}$		Oliver Bartels F+E Ottostr. 3 D-85435 Erding Tel. (08122) 9729-0 Fax. (08122) 9729-10
Entworfen	Datum		Werkstoff				

Panel 28TE		Ersatz für
------------	--	------------

Änderungen nur im CAD-System!

Alle Betriebsmittel vorbehalten. Alle Rechte vorbehalten.
Proprietary data, company confidential. All rights reserved.
Confie a titre de secret d'entreprise. Tous droits réservés.
Comunicado como secreto empresarial. Reservados todos los derechos.
Confiable como secreto industrial. Reservados todos los derechos.

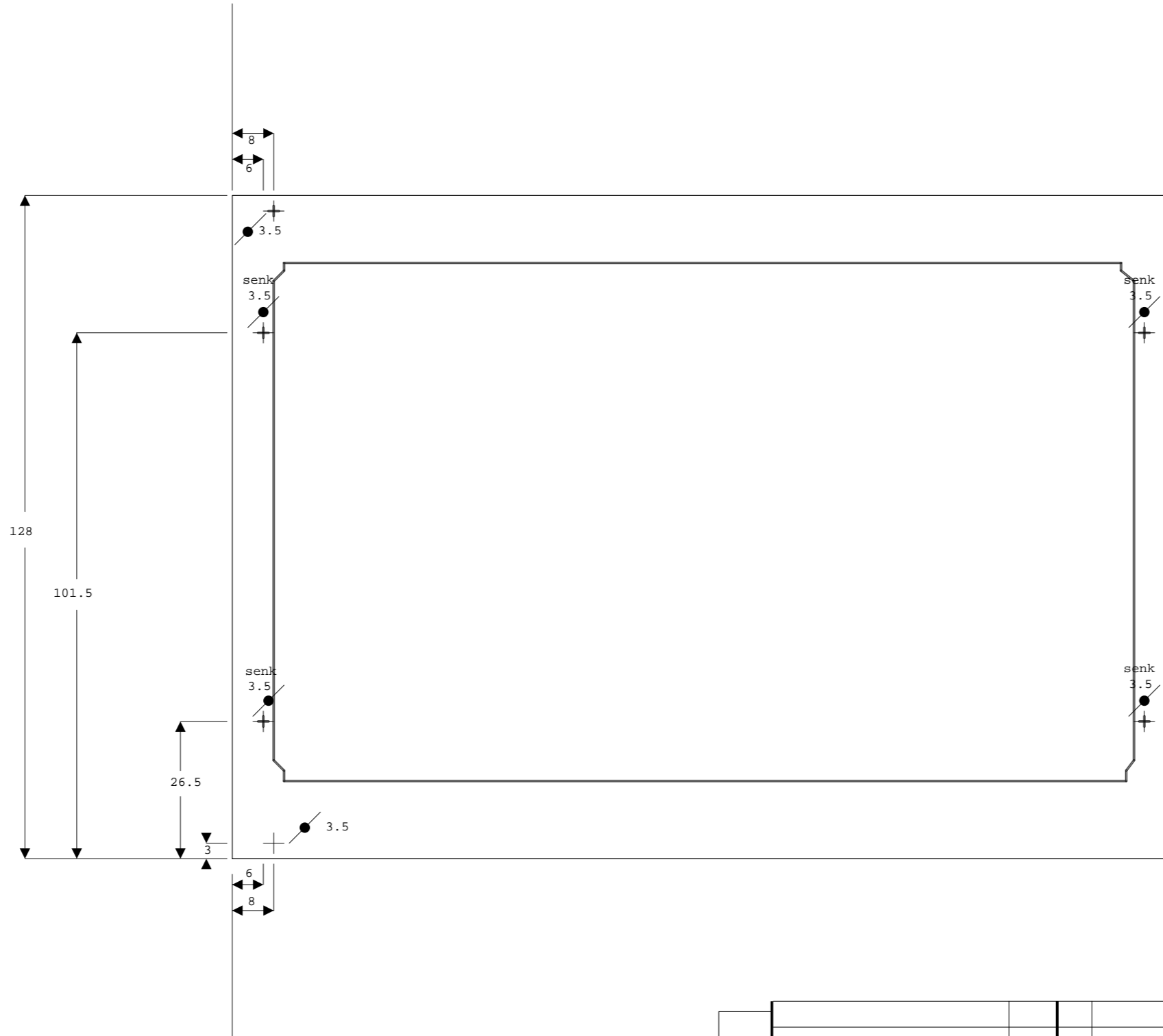

Typ	Verwendung	Teil	Ind.	Änderung		Veran-	Durch-	Freigabe-	Ausgabe-	Name	
										Ja	Nein
										Ja	Nein
										Ja	Nein
										Ja	Nein
										Ja	Nein
										Ja	Nein
										Ja	Nein
										Ja	Nein
										Ja	Nein
										Ja	Nein
										Ja	Nein
										Ja	Nein
										Ja	Nein
										Ja	Nein
										Ja	Nein
										Ja	Nein
										Ja	Nein
										Ja	Nein
										Ja	Nein
										Ja	Nein
										Ja	Nein
										Ja	Nein
										Ja	Nein

Oberflächenbehandlung		Maßstab	Fertigungs-Toleranz	Nichtbemaßte Radien		Schwindung			 Oliver Bartels F+E Ottostr. 3 D-85435 Erding Tel. (08122) 9729-0 Fax. (08122) 9729-10	
Entworfen	Datum		Werkstoff	x=	z	y=	z			

Panel 36TE

Ersatz für

Auslieferndes Werk

Bartels AutoEngineer A3BLATT

Änderungen nur im CAD-System!

Alle Rechte vorbehalten. Alle Rechte vorbehalten.
 Proprietary data, company confidential. All rights reserved.
 Confie a titre de secret d'entreprise. Tous droits réservés.
 Comunicado como secreto empresarial. Reservados todos los derechos.
 Confiado como secreto industrial. Reservados todos los derechos.

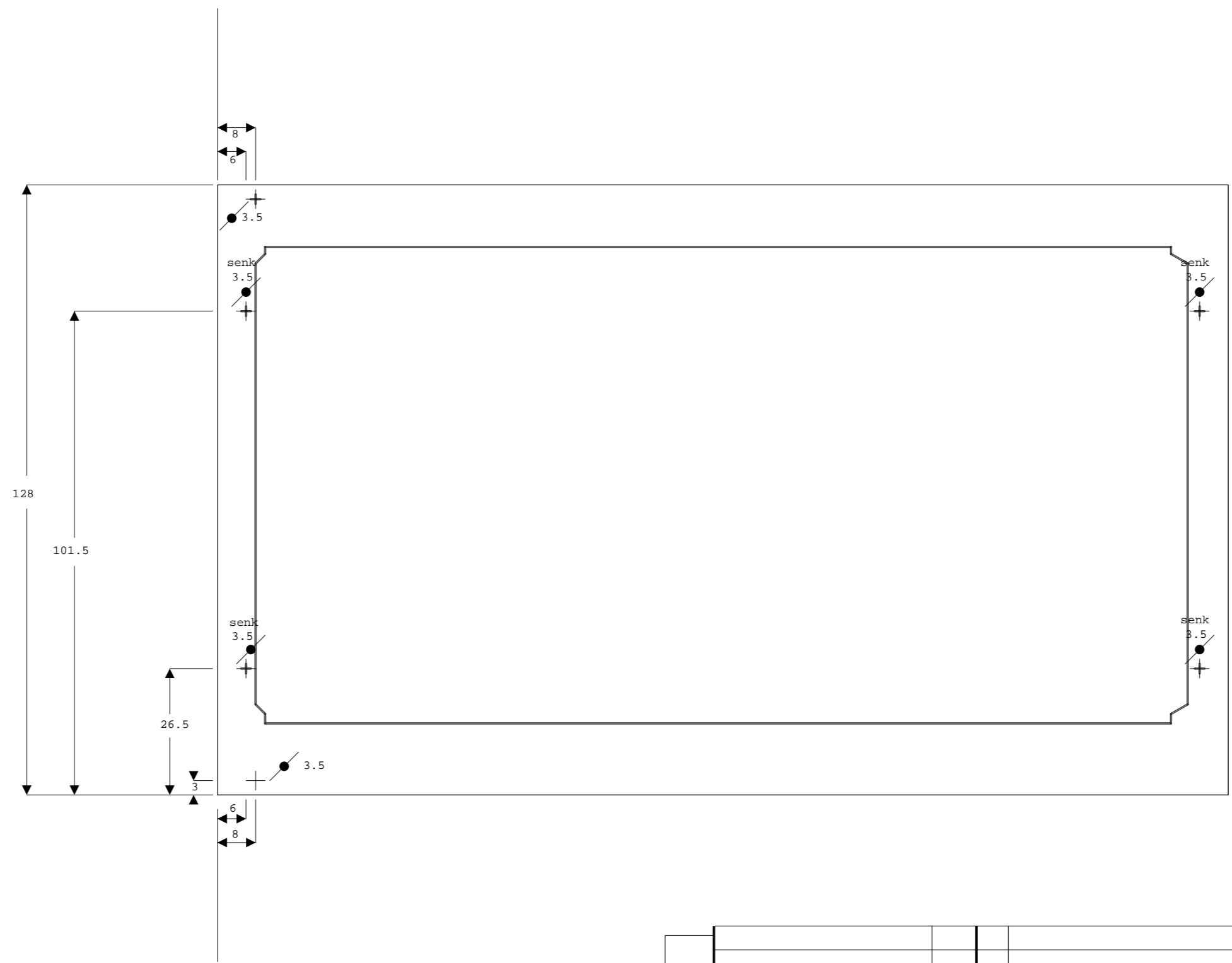

Typ	Verwendung	Teil	Ind.	Änderung		Veran- lassung	Durch- führung	Freigabe- erford.	Ausgabe- datum	Name
										Ja / Nein
										Ja / Nein
										Ja / Nein
										Ja / Nein
										Ja / Nein
										Ja / Nein
										Ja / Nein

Oberflächenbehandlung		Maßstab	Fertigungs- Toleranz	Nichtbemaßte Radien			Oliver Bartels F+E Ottostr. 3 D-85435 Erding Tel. (08122) 9729-0 Fax. (08122) 9729-10
Entworfen		Datum	Werkstoff	Schwindung			
Panel 42TE			Ersatz für				

Änderungen nur im CAD-System!

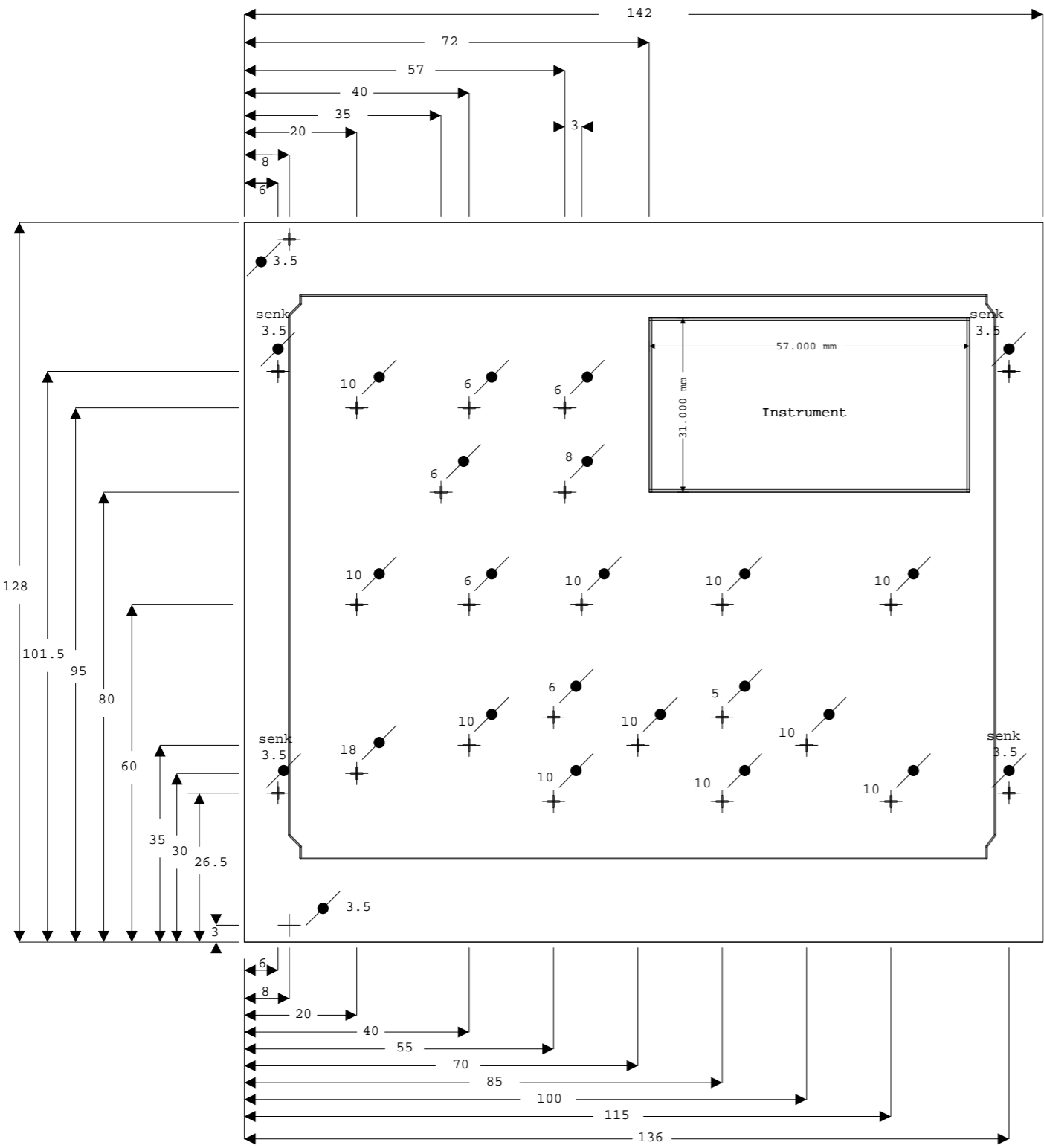

Typ	Verwendung	Teil	Ind.	Änderung	Veran-	Durch-	Freigabe-	Ausgabe-	Name		
					lassung	f•hrung	erford.	datum			
									Ja / Nein		
									Ja / Nein		
									Ja / Nein		
									Ja / Nein		
									Ja / Nein		
									Ja / Nein		
									Ja / Nein		
				Maßstab	Fertigungs-	Nichtbemaßte					
					Toleranz	Radien					
Oberflächenbehandlung				Werkstoff	Schwindung	x= %					
					y= %						
					z= %	Oliver Bartels F+E Ottostr. 3 D-85435 Erding Tel. (08122) 9729-0 Fax. (08122) 9729-10					
Entworfen	Datum	Panel IDA1			Ersatz für						

Alle Rechte vorbehalten. Alle Rechte vorbehalten.
 Proprietary data, company confidential. All rights reserved.
 Confie a titre de secret d'entreprise. Tous droits réservés.
 Comunicado como secreto empresarial. Reservados todos os direitos.
 Confialdo como secreto industrial. Reservados todos los derechos.

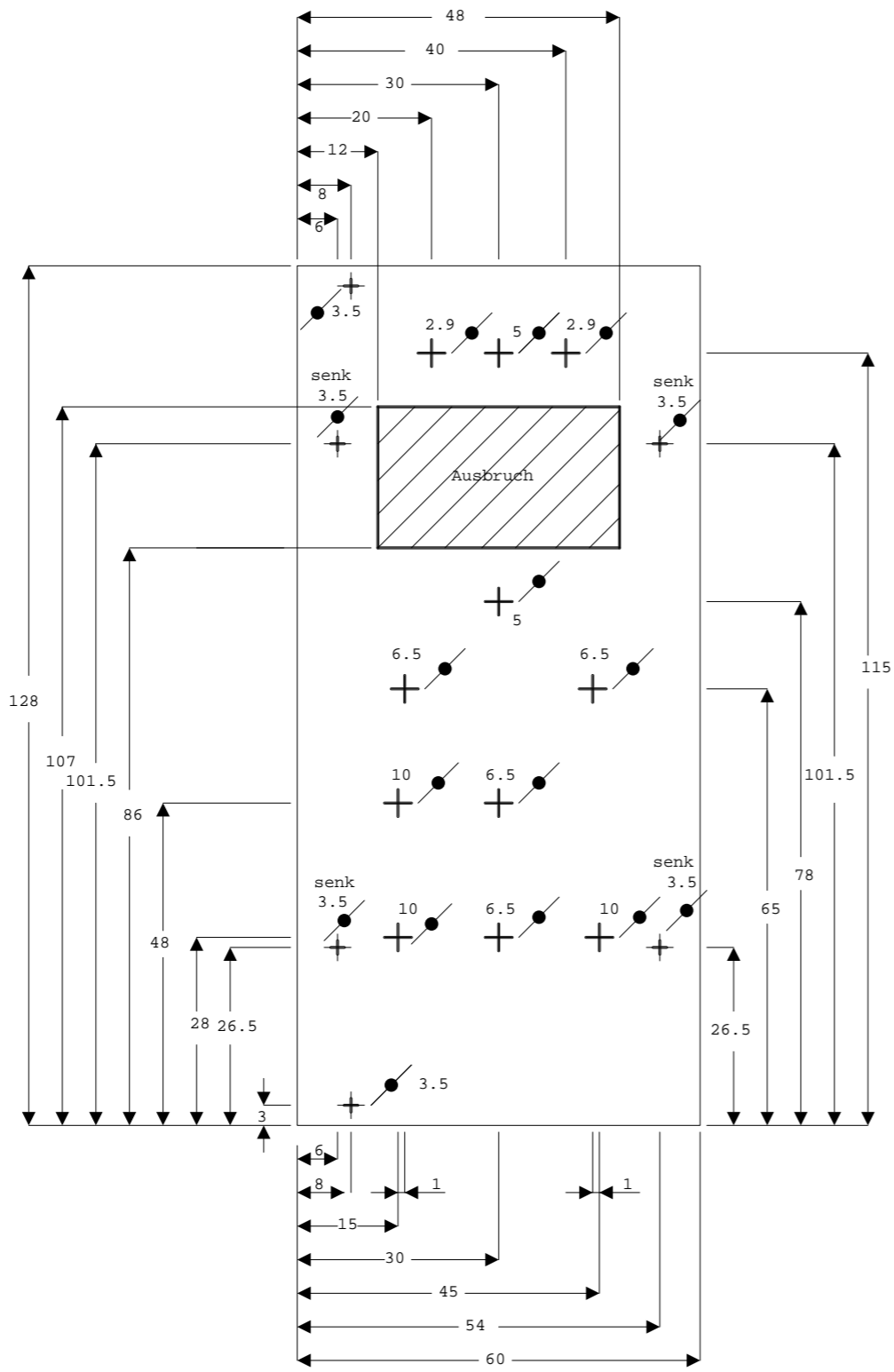

Material ALU 2mm
 Alle Angaben sind in mm

Typ	Verwendung	Teil	Ind.	Änderung	Veranlassung	Durchführung	Freigabeerford.	Ausgabedatum	Name
									Ja / Nein
									Ja / Nein
									Ja / Nein
									Ja / Nein
									Ja / Nein
									Ja / Nein
				Maßstab	Fertigungs-Toleranz	Nichtbeaßte Radien			
Oberflächenbehandlung				Werkstoff		Schwindung x= % y= % z= %	Oliver Bartels F+E Ottostr. 3 D-85435 Erding Tel. (08122) 9729-0 Fax. (08122) 9729-10		
Entworfen		Datum		Panel PA2D				Ersatz für	

Auslieferndes Werk

Änderungen nur im CAD-System!

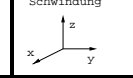

Typ	Verwendung	Teil	Ind.	Änderung	Veran- lassung	Durch- führung	Freigabe- erford.	Ausgabe- datum	Name
									Nein
									Ja
									Nein
									Ja
									Nein
									Ja
									Nein
									Ja
									Nein

Oberflächenbehandlung			Maßstab	Fertigungs- Toleranz	Nichtbenadete Radien	 Oliver Bartels F+E Ottostr. 3 D-95435 Erding Tel. (08122) 9729-0 Fax. (08122) 9729-10
Entworfen	Datum	Werkstoff			Schwindung  x= t y= t z= t	
Panel PA19_1HE						Ersatz f.r

Diese Zeichnung nur im QM-System

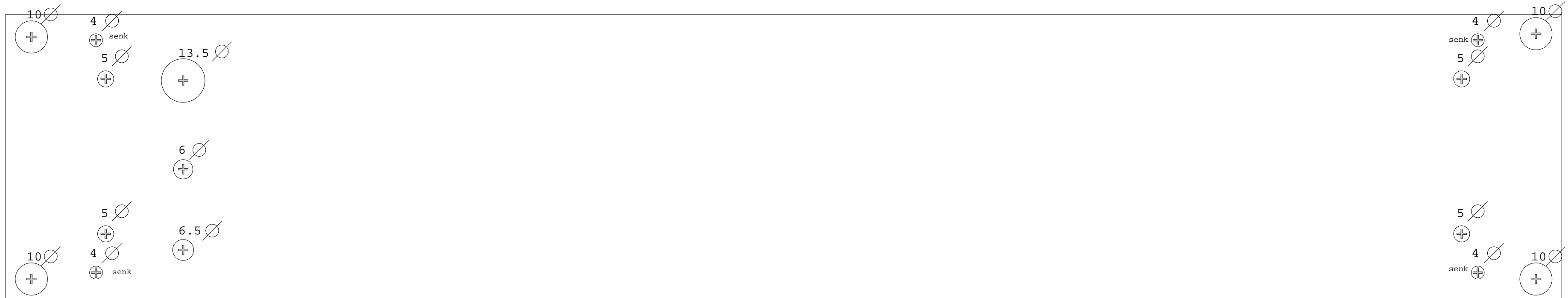

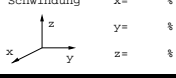
													Ja	Nein
													Ja	Nein
													Ja	Nein
													Ja	Nein
													Ja	Nein
													Ja	Nein
													Ja	Nein
													Ja	Nein
Typ	Verwendung	Teil	Ind.	Änderung				Veran- lassung	Durch- führung	Freigabe- erford.	Ausgabe- datum	Name		
Oberflächenbehandlung		Maßstab	Fertigungs- Toleranz	Nichtbenannte Radien				 Oliver Bartels F+E Ottostr. 3 D-95435 Erding Tel. (08122) 9729-0 Fax. (08122) 9729-10						
			Werkstoff	Schwindung $x=$ $y=$ $z=$ 										
Entworfen	Datum	Panel PA19_2HE				Ersatz für								
Auslieferndes Werk						Bartels AutoEngineer								

Diese Zeichnung nur im CAD-System!